

INSTRUCTION SHEET

Push in Socket Operating Instructions SJ Series

Type No. SJ1S-21L, SJ2S-21L

Read this instruction sheet to make sure of correct operation before starting installation, wiring, operation, maintenance, and inspection of this product. Also make sure that this instruction sheet is kept by end users. Special electrical expertise is required to install, wire, and operate the SJ series sockets. People without such expertise must not use the SU series sockets.

Safety Precautions

All SJ Series sockets are manufactured under IDEC's rigorous quality control system, but users must add a backup or failsafe provision to the control system using the SJ series sockets in applications where heavy damage or personal injury may be caused in case the SJ series sockets should fail.

In this instruction sheet, safety precautions are categorized in order of importance to Warning and Caution:

WARNING

Warning notices are used to emphasize that improper operation may cause severe personal injury or death.

CAUTION

Caution notices are used where inattention might cause personal injury or damage to equipment.

WARNING

- Turn off power to the SJ series sockets before starting installation, removal, wiring, maintenance, and inspection of the SJ series sockets. Failure to turn power off may cause electrical shocks or fire hazard.

CAUTION

- Use proper wires to meet the voltage and current requirements.
- Make sure that relay and output equipment are connected completely. Incomplete connection may cause overheating, resulting in fire hazard.
- To ensure safety, make sure that all descriptions in the operation instructions are followed strictly.
- Prevent metal fragments and pieces of wire from dropping inside the SJ series sockets. Ingress of such fragments and chips may cause fire hazard, damage, or malfunction.
- When disposing of the SJ series sockets, do so as an industrial waste.
- Do not disassemble, repair, or modify the SJ series sockets.
- Make sure that wires are connected correctly. Incorrect connection may cause malfunction, overheating, or fire hazard.

1. Wiring Instructions

When wiring, use the applicable wires shown below.

Applicable Wire (stranded and solid)	0.14 to 1.5 mm ² (AWG26 to 16)
Wire Strip Length (When the ferrule is not used)	10 to 11mm (* 1)
Ferrule	Refer to "Wire Size and Recommended Ferrule"

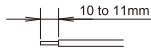

(*1) Strip the sheath of the wire 10 to 11 mm from the end.

Wire Size and Recommended Ferrules

Applicable Wire (stranded)	Wire Strip Length	With insulation cover	
		Order number	
26 0.14	10 to 11 mm	S3TL-F014-12WC	
24 0.25	10 to 11 mm	S3TL-H025-12WJ	
22 0.34	10 to 11 mm	S3TL-H034-12WT	
	12 to 13 mm	S3TL-H05-14WA	
20 0.50	10 to 11 mm	S3TL-H05-16WA	
	12 to 13 mm	S3TL-H05-16WA	
18 0.75	10 to 11 mm	S3TL-H075-14WW	
	12 to 13 mm	S3TL-H075-16WW	
18 1.00	10 to 11 mm	S3TL-H10-14WY	
	12 to 13 mm	S3TL-H10-16WY	
16 1.50	10 to 11 mm	-	

Recommended Tools (Optional)

Name	Type No.	Order number	Applicable wire
Crimping tool	S3TL-CR04T	S3TL-CR04T	0.5-4mm ²
	S3TL-CR06D	S3TL-CR06D	0.25-6mm ²
	PZ6 ROTO L(*)	-	0.14-6mm ²
Flat blade screwdriver	S3TL-D04-25-75	S3TL-D04-25-75	-
Stripper	S3TL-ST06	S3TL-ST06	0.08 - 6mm ²

(*) :Manufactured by Weidmuller

Refer to the table below for other companies' ferrules that correspond to "Wire Size and Recommended Ferrules". Check each company's catalog for details and select.

Applicable Wire (stranded)	Weidmuller		PHOENIX CONTACT		WAGO	
	Without insulation cover	With insulation cover	Without insulation cover	With insulation cover	Without insulation cover	With insulation cover
26 0.14	-	H0.14/12 GR SV	-	Al 0.14-8 GY-1000	-	-
24 0.25	-	H0.25/12 HBL	-	Al 0.25-8 YE	-	FE-0.25-8N-YE
22 0.34	-	H0.34/12 TK	-	Al 0.34-8 TQ	-	FE-0.34-8N-TQ
20 0.50	H0.5/10	OR	A 0.5-8	Al 0.5-8 WH	FE-0.5-8	FE-0.5-8N-WH
	-	H0.5/16 OR	A 0.5-10	Al 0.5-10 EH	FE-0.5-10	FE-0.5-10N-WH
18 0.75	H0.75/10	W	A 0.75-8	Al 0.75-8 GY	FE-0.75-8	FE-0.75-8N-GY
	-	H0.75/16 W	A 0.75-10	Al 0.75-10 GY	FE-0.75-10	FE-0.75-10N-GY
18 1.00	H1.0/10	GE	A 1.0-8	-	FE-1.0-8	-
	-	H1.0/16 GE	A 1.0-10	-	FE-1.0-10	-
16 1.50	H1.5/10	-	A 1.5-10	-	FE-1.5-10	-

CAUTION

- Make sure that the stranded wires do not loosen when using wiring without ferrules.
- Note the crimping dimensions, when using tools other than the recommended crimping tool. Please see 3-3 for details.
- Use a flat blade screwdriver with a blade size of 0.4x2.5mm.

2. Parts Description and Terminal

Parts description

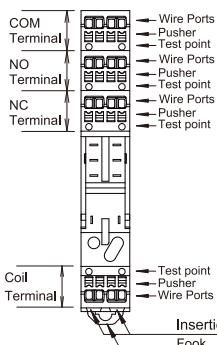

SJ1S-21L Terminal Arrangement

SJ2S-21L Terminal Arrangement

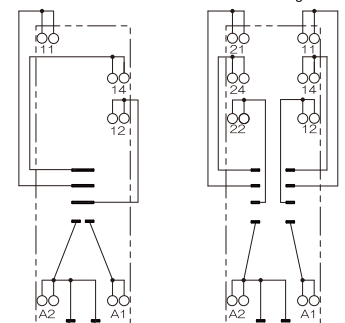

TOP VIEW

Note: Two cable ports are provided for each terminal.

3. Wiring Instructions

3-1. Inserting the wire

Insert the wire to the back of the wire port. When using a stranded wire, insert the wire while pressing the pusher with a flathead screwdriver.

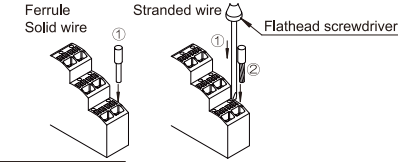

3-2. Removing the wire

Pushing the pusher with a flathead screwdriver, remove the wire straight in the arrow direction.

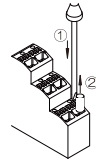

CAUTION

- After wiring, tug lightly to make sure that the wire is properly connected.
- Operate the pusher with a force of 40N. Do not press excessively.
- Do not pull the wire out without depressing the pusher. When pulling the wire, be sure to pull in a straight direction. Otherwise, the socket may be damaged.
- Use a recommended flat blade screwdriver with the blade size of 0.4x2.5mm.

3-3. Cautions on ferrule crimp shape and connection

CAUTION

- Choose an appropriate ferrule for the wire.
- Cut the wire carefully to get a flat end.
- Make sure that ferrule sleeve is completely filled by the conductor. Depending on the cross section, the conductor should protrude approx. 0 to 1 mm from the ferrule sleeve.
- When crimping, refer to the instructions of the crimping tool.
- Maximum connectable crimping size is W2.4xH1.9. Make sure that the ferrule size will be smaller than this dimension.
- If a tool other than the recommended crimping is used, the ferrule may not be crimped to the appropriate size and the clamp or spring inside the socket may be deformed and may not operate normally.
- Pin crimp terminals cannot be used.

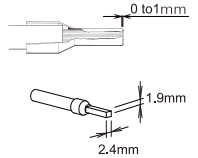

4. Installing / Removing the relay

4-1. Installing the relay

- (1) Tilt the release lever in the direction of the arrow and release the lock.
- (2) Insert the relay and tilt the release lever in the direction of arrow.

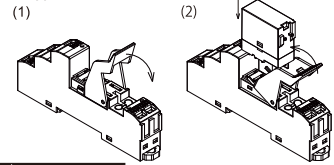

4-2. Removing the relay

- Remove the relay by tilting the release lever in the direction of the arrow while holding it tightly with fingers so that it does not fall.
- (Relay installation state) (Relay release state)

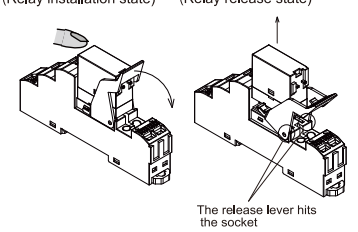

CAUTION

- Push the relay until it is completely installed. If the mounting is incomplete, the relay may fall off. (Relay installation state)

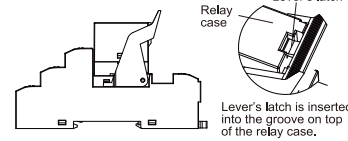

CAUTION

- When removing the relay, the relay may pop out and the relay may be lost. Remove it while preventing it from popping out with your fingers.
- The release lever has a detachable structure. If it is operated with excessive force, it will come off the socket, causing the relay to fall off or be damaged.

5. Installing the Marking Plate

Install the marking plate as shown in the diagram below. Mark on the surface using an oil-based marker, or affix a sticker with markings. The size of the marking surface is 8.4mm x 15mm.

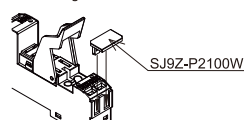

6. Using the Jumper

Insert the jumper to the back of the jumper slot. To remove, insert the flat blade driver into the slot below and pull out. The rated current is 2A, so use it at 2A or less.

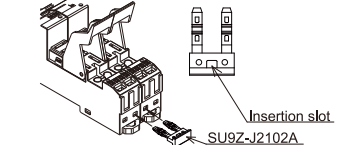

7. Installing the Release Lever

When using SJ9Z-C21R release lever, attach the release lever to appropriate protrusion of the socket. To install, see below diagram.

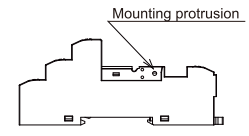
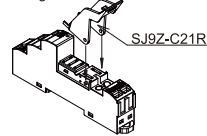

8. Safety Precaution

8-1. When using with RJ series relay, check the derating in the table below before using.

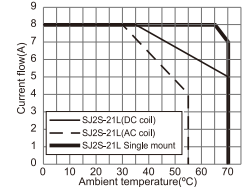
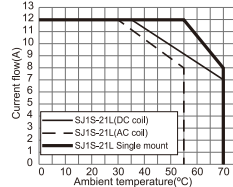

8-2. When using RF2S (forced guide relay), use a voltage of 150V or less.

CAUTION

- When used at a voltage higher than 150V, it does not satisfy the reinforced insulation performance of the forced guide relay.

8-3. Rail Mounting and Removing

CAUTION

- When mounting the socket on a DIN rail, be sure to fix both sides with End Clip BNL6 (option).
- Do not mount the socket on the rail and remove the socket from the rail at temperatures below -20°C, otherwise the socket may be damaged.

9. Disposal Precautions Usage Precautions

CAUTION

- When disposing of this product, treat it as industrial waste.

IDEC CORPORATION

<http://www.idec.com>

1175 Elko Drive Sunnyvale, CA 94089-2209, USA

Manufacturer: IDEC CORP.

2-6-64 Nishimiyaohara Yodogawa-ku, Osaka 532-0004, Japan

APEM SAS

55, Avenue Edouard Herriot BP1, 82303 Caussade Cedex, France