

INSTRUCTION SHEET

Touch less Switches Φ22 CW Series Flash Silhouette

Confirm that the delivered product is what you have ordered. Read this instruction sheet to make sure of correct operation. Make sure that the instruction sheet is kept by the end user.

SAFETY PRECAUTIONS

CAUTION

Caution notices are used where inattention might cause personal injury or damage to equipment.

1 Type

CW□H-DM1△* * C

GR: GREEN RED
2 colors illumination

N: Direct Output
T: ON/OFF Delay Timer Output

1: Resin Bezel
4: Metal Bezel

2 Installation

To mount the product onto a panel, tighten the locking ring to a tightening recommended torque using ring wrench MW9Z-T1. Mount the product on a flat surface.

If installed on an uneven surface, the product may be damaged or the waterproof performance may be impaired.

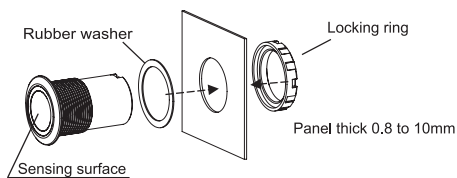

Mounting hole layout

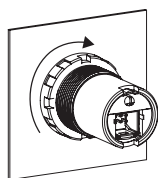

Locking ring
Torque value
1.2N · m

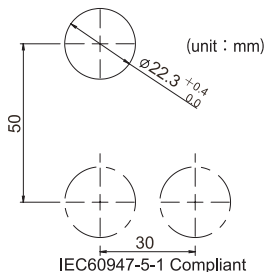

Please determine the mounting pitch consider operability and wiring.

3 Specifications

TYPE No.	CW1H-DM1NGR-C	CW1H-DM1TGR-C	CW4H-DM1NGR-C	CW4H-DM1TGR-C
Ambient Temperature	Operating: -25 to +55°C, Storage: -35 to +70°C (no freezing)			
Ambient Humidity	Operating: 35 to 95%RH, Storage: 35 to 95%RH (no condensation)			
Detection System	Diffuse-reflective			
Adjustment range of Maximum sensing range	120 to 350mm [using white mat paper, 200×200mm] If detection object is hand, approximately 70 to 270mm (reference value)			
Light Source	Infrared LED			
Power Voltage	12 to 24V DC Ripple ±10% (main circuit and illumination part)			
Current Consumption	40mA maximum (main circuit), 20mA maximum (illumination part)			
Control Output	Solid State Relay (PhotoMOS) output Load voltage: 26.4V DC maximum		Voltage drop : 1.0V maximum Rated operational current (Load current): 100mA	
Protection Circuit	Protection circuit on reverse connection of power supply			
Response Time	Turn on ≒ 2.5ms, Turn off ≒ 1ms			
ON Delay	-	0.5±0.1s	-	0.5±0.1s
OFF Delay	-	2.0±0.5s	-	2.0±0.5s
Material	Bezel · Body	PA66		Aluminium alloy
	Lens	PMMA		
Light color	Light1: Green, Light2: Red			
Degree of protection	IP65, IP67, UL, Type4X (OUTDOOR USE) ※Front panel			

4 Notes for Operation

- Do not use the product during the transient time of 100ms after turning on the power supply.
- If the product and the load are connected to different power supplies, the product must always be turned on first.
- Do not install the product nearby induction device, or heat source. Choose locations free from frequent vibrations, shocks, dust, toxic gases, water, oil, chemicals, icing and dew, so as to prevent malfunctions and damage.
- Do not expose the sensing surface to sunlight or other direct light projections.
- Please be caution that the detection distances should be extremely long with specular objects or retroreflectors, it may detect in an unexpected range.
- Do not use the product with water drops, dirt etc, remaining on the sensing surface, as unintended operation and detection performance may change.
- To remove dust and moisture build-up, use soft dry cloth.
- PMMA is used for optical elements. Do not use organic solvents such as ammonia, caustic soda, alcohol or thinner for cleaning.

CAUTION

- Do not apply the voltage over the rated range or AC voltage, otherwise the switch may blow out or burn.

5 Wiring

- Turn off the power supply before wiring.
- The incorrect wiring may cause damage to the internal circuit please refer the wiring diagram.
- The power voltage must use within the rated range.
- When using a switching power supply, make sure to ground the FG (frame ground) terminal.
- Do not install the product wiring in the same conduit with high-voltage lines and power lines.
- If the wiring is long, or if there is a risk influence from power source and electromechanical devices etc, use it as an independent wiring.

- If voltage is applied to the Light1 and Light2 terminals due to inductive noise, etc., the illuminated part may glow faintly. In such cases, take countermeasures by connecting the shunt resistors shown in the table below between Light1 and 0V and between Light2 and 0V, respectively.

Shunting resistor R	
Resistance value	Power
20kΩ	0.25W minimum

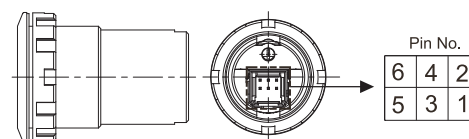

WIRING DIAGRAM

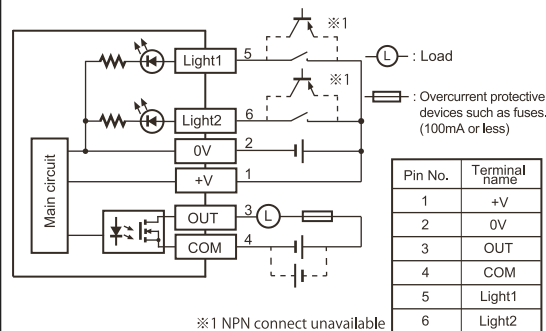

Pin No.	Terminal name
1	+V
2	0V
3	OUT
4	COM
5	Light1
6	Light2

6 Dimensions

(unit : mm)

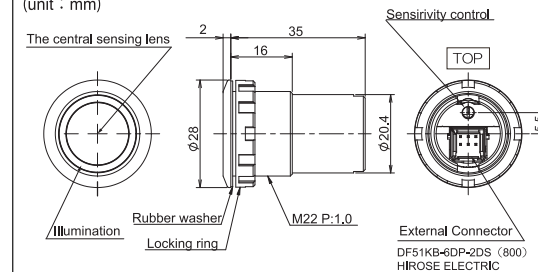

<Connector>

Parts	Model number	Manufactures	Qty
Crimp socket	DF51K-6DS-2C(800)	HIROSE ELECTRIC	1
Socket contact	DF51K-22SCF(800) or DF51K-22SC(800)		6

<Cable (Sold separately)>

CW9Z-CN-※ (※Cable length[mm])

• AWG #22

Regarding except 200mm length Please Contact Sales.

(unit : mm)

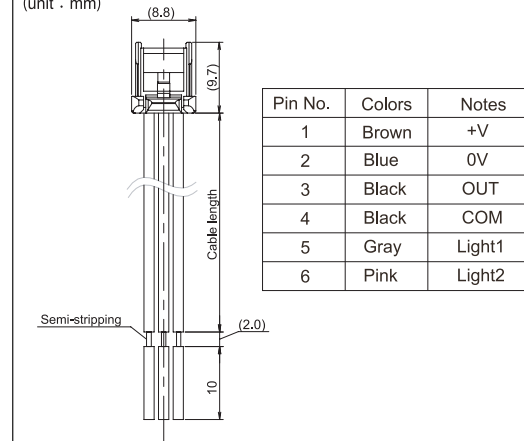

7 Precaution for Disposal

- Dispose of the CW-H as an industrial waste.

EU Authorized Representative: APEM SAS
55, Avenue Edouard Herriot BP1, 82303 Caussade Cedex, France
UK Authorized Representative: APEM COMPONENTS LIMITED
Drakes Drive, Long Crendon, Buckinghamshire, HP18 9BA, UK
Manufacturer: IDEC CORPORATION
2-6-64, Nishimiyahara, Yodogawa-ku, Osaka, Japan

IDEC CORPORATION

<https://www.idec.com>
2022.08