

NH1 Series Circuit Protectors

Wide Range of Applications from Office Automation and Consumer Use to Factory Automation.

- Compact, lightweight, and high-performance circuit protectors.
- Rocker type snaps into a panel.
- Rated voltage: 250V AC and 65V DC
- 35mm-wide DIN rail mounting (NH1V)
- Available with dual-coil
- Available with auxiliary contact or alarm contacts.
- Available with inertia delay
- Hydraulic-magnetic tripping system
- Safe trip-free mechanism
- Available in tab terminal and screw-terminal.

This product is recognized by Underwriters Laboratories under UL1077 as a "Supplementary Protector."

Applicable Standards	Mark	Certification Organization / File No.
UL1077 CSA C22.2 No. 235 (Note 1)		UL/c-UL recognized File No. E68029
EN60934 (VDE0642) (Note 2)		No. 107852
EN60932 (Note 2)		EU Low Voltage Directive
GB17701		CCC No. 2005010307152360
Electrical Appliance and Material Safety Law Technical Standard		JET

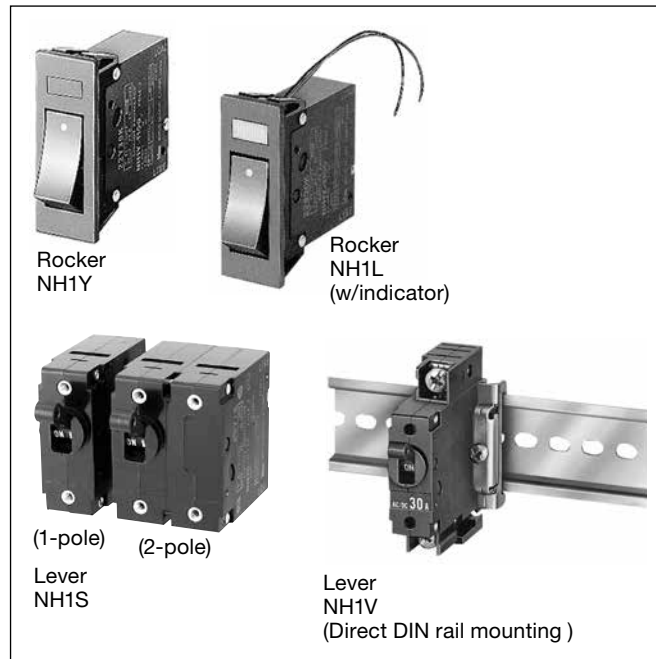

For details, see the list of standard certified products in the back of this catalog.

Note 1: Series trip, relay trip, dual coil (for AC)





Note 2: Series trip

Specifications

Model	NH1S	NH1Y	NH1L	NH1V	Dual-coil
					NH1S
Operator Style	Lever	Rocker	Rocker (w/indicator)	Lever	Lever
Protection Method	Hydraulic-magnetic tripping system				Hydraulic-magnetic tripping system
Internal Circuit	Series trip (Current trip) Relay trip (Voltage trip)	Series trip with auxiliary contacts	Series trip with alarm contacts (NH1S and NH1V only)	Series trip with alarm contacts (NH1S and NH1V only)	Series trip (Current trip) + Relay trip (Voltage trip)
No. of Poles	1, 2, 3 poles	1, 2 poles	1, 2 poles	1, 2, 3 poles	1, 2 poles
Rated Voltage	250V AC 50/60Hz, 65V DC				250V AC 50/60Hz, 65V DC
Minimum Applicable Load	24V AC/DC, 100mA (reference value)				
Rated Current	Current trip: 0.5A, 0.75A, 1A, 2A, 3A, 5A, 7.5A, 10A, 15A, 20A, 25A, 30A				Current trip: 2A, 3A, 5A, 7.5A, 10A, 15A
Trip Voltage	100V AC 50/60Hz, 24V DC (operating at 90% of the rated voltage or higher, at 25°C) Voltage application duration: 1 sec maximum Trip time: 0.05 sec maximum (at the rated voltage)				Trip coil voltage: 24V DC, 100V AC (operating at 90% of the rated voltage or higher, at 25°C) Voltage application duration: 1 sec - max. Trip time: 0.05 sec max. (at the rated voltage)
Rated Interrupting Current	250V AC 50/60Hz 1000A, 65V DC 1000A (UL/C-UL ratings) 220V AC 50/60Hz 1000A (☞)				
Auxiliary Contact Alarm Contact	SPDT microswitch 250V AC, 3A (resistive load)				-
Reference Temperature	+25°C				
Operating Temperature	-40 to +85°C (no freezing)				
Storage Temperature	-40 to +85°C (no freezing)				
Operating Humidity	45 to 85% RH (no condensation)				
Storage Humidity	45 to 85% RH (no condensation)				
Insulation Resistance	100 MΩ minimum (500V DC megger)				
Dielectric Strength	Between operator and live part, between terminals when main contacts are open, between live parts of different poles: 3750V AC, 1 min (NH1V: 1500V AC, 1 min) Between terminals when auxiliary contacts are open: 600V AC, 1 min Between main terminal and auxiliary contact terminal: 1500V AC, 1 min				Between operator and live part, between terminals when main contacts are open, between live parts of different poles, between voltage trip terminal and main terminal: 1500V AC, 1 min.
Vibration Resistance	Damage limits: 10 to 55 Hz, 100 m/s ² (1, 2, 3 pole) Operating extremes: 10 to 55 Hz, 98 m/s ² (1, 2, 3 pole) (with the rated current applied)				
Shock Resistance	Damage limits: 1000 m/s ² , Operating extremes: 500 m/s ² with the rated current applied. (Auxiliary/alarm contact: 300 m/s ²)				
Life	10,000 cycles min. (Electrically 6,000 cycles: 6 operations per minute at the rated current, mechanically 4,000 cycles: 6 operations per minute)				
Terminal Style	Main terminal: Tab terminal #250, M4 screw terminal Auxiliary terminal: Tab terminal #110			Main terminal: M4 screw terminal (20A max.) M5 screw terminal (25, 30A) Auxiliary terminal: M3.5 screw terminal	Main terminal: Tab terminal #250 Auxiliary terminal: Tab terminal #187
Mounting Style	Screw mounting	Snap mounting		Screw mounting, DIN rail mounting	Screw mounting
Weight (Approx.)	1-pole: 45g 2-pole: 90g 3-pole: 135g	1-pole: 50g 2-pole: 100g		1-pole: 65g 2-pole: 130g 3-pole: 195g	1-pole: 45g 2-pole: 90g

- Do not use the NH1 series circuit protectors in environments where they are exposed to extreme temperature, humidity, dust, corrosive gases, vibration, shock, or in a circuit where inrush current may be present, otherwise unnecessary operations and damage may occur.

Rocker Color, Rocker Indication (NH1Y/NH1L)

Rocker Color (Code)	Rocker Indication (Code)
Black (blank) Red (R), Green (G), White (W)	 (blank)
	 (A)
	 (C)
	 (D)

Note: Rocker indication is white (black when rocker color is white).

Operating Voltage of Indicator (NH1L)

Indicator	Rated Voltage	Code	
Neon (Red)	125V AC, 50/60Hz (operating voltage: 100 to 125V AC)	1	
LED (Red) [Note]	For AC/DC (operating voltage: within +10% of the rated voltage)	6V	3
		12V	4
		24V	5
		48V	6

Note: Both indicators contain a current limiting resistor.

Lever Color (NH1S, NH1V): Black

Operation of Auxiliary Contacts

Since auxiliary contact operations are interlocked with ON/OFF positions of main terminal, operating status of the circuit protector can be monitored using a lamp. Auxiliary contacts also serve as a control of auxiliary circuits.

Operator Position	NO Contact	NC Contact
ON	Closed	Open
Tripped	Open	Closed
OFF	Open	Closed

Operation of Alarm Contacts

Alarm contacts are not interlocked with main contacts and operate only when an overcurrent occurs.

Operator Position	NO Contact	NC Contact
ON	Open	Closed
Tripped	Closed	Open
OFF	Open	Closed

Part No. Example

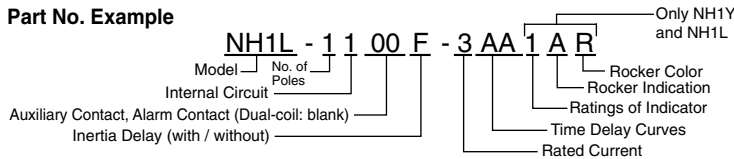

Part No. Development

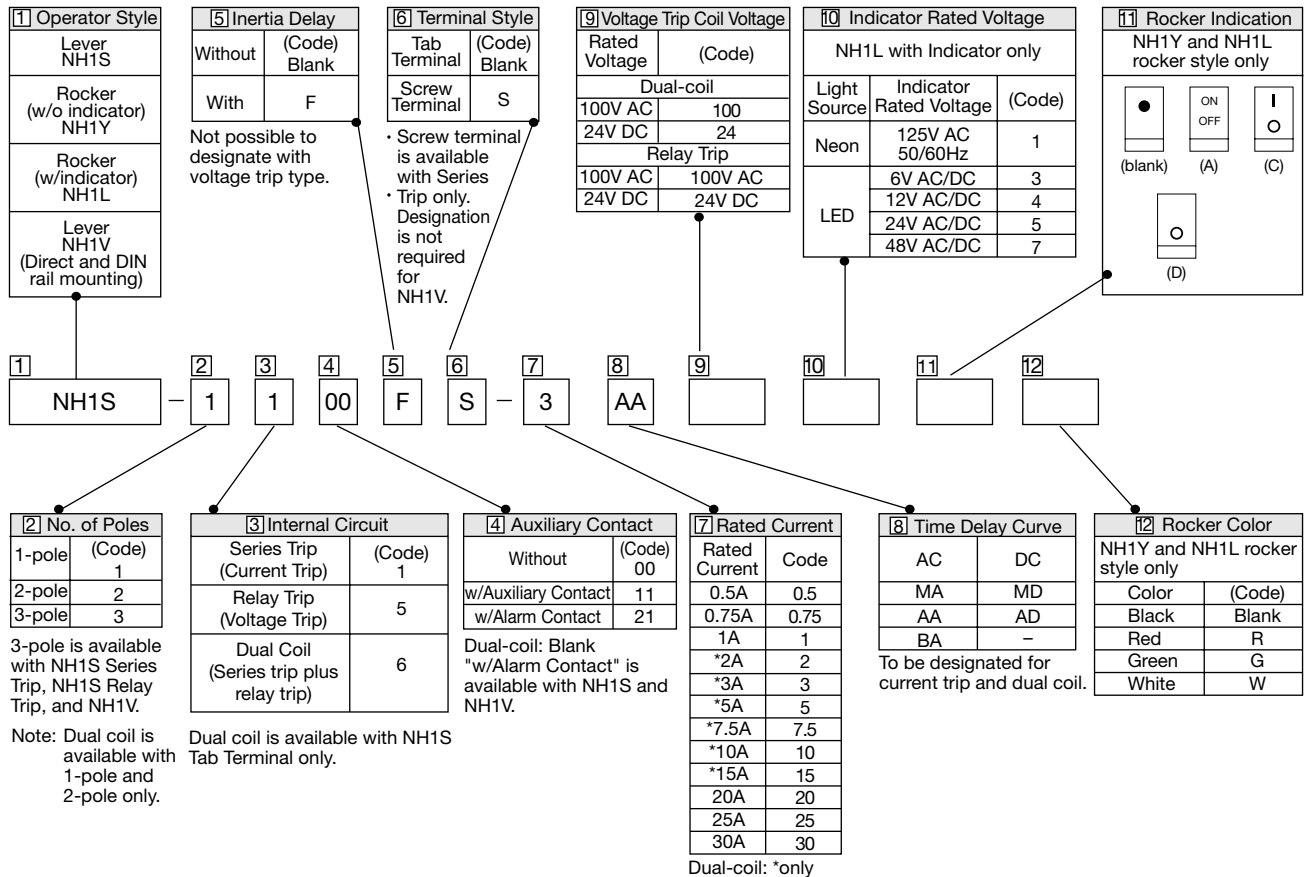

NH1 Series Circuit Protectors

NH1S (Lever)

Specify a rated current, time delay curve, and rated voltage in place of [7] [8] [9].

Package Quantity: 1

Internal Circuit	No. of Poles	Terminal Style	Inertia Delay	Auxiliary Contact Alarm Contact	Part No.	Designation Code							
						[7] Rated Current	[8] Time Delay Curve	[9] Rated Voltage					
Series Trip Current Trip	1	Tab Terminal	Without	Without	NH1S-1100- [7] [8]								
				w/Auxiliary Contact	NH1S-1111- [7] [8]								
				w/Alarm Contact	NH1S-1121- [7] [8]								
		With	Without	NH1S-1100F- [7] [8]									
			w/Auxiliary Contact	NH1S-1111F- [7] [8]									
			w/Alarm Contact	NH1S-1121F- [7] [8]									
	Screw Terminal	Without	Without	NH1S-1100S- [7] [8]									
			w/Auxiliary Contact	NH1S-1111S- [7] [8]									
			w/Alarm Contact	NH1S-1121S- [7] [8]									
		With	Without	NH1S-1100FS- [7] [8]									
			w/Auxiliary Contact	NH1S-1111FS- [7] [8]									
			w/Alarm Contact	NH1S-1121FS- [7] [8]									
Series Trip Current Trip	2	Tab Terminal	Without	Without	NH1S-2100- [7] [8]	0.5 0.75 1 2 3 5 7.5 10 15 20 25 30	AA BA MA AD MD	-					
				w/Auxiliary Contact	NH1S-2111- [7] [8]								
				w/Alarm Contact	NH1S-2121- [7] [8]								
				With	Without				NH1S-2100F- [7] [8]				
					w/Auxiliary Contact				NH1S-2111F- [7] [8]				
					w/Alarm Contact				NH1S-2121F- [7] [8]				
		Screw Terminal	Without	Without	NH1S-2100S- [7] [8]								
				w/Auxiliary Contact	NH1S-2111S- [7] [8]								
				w/Alarm Contact	NH1S-2121S- [7] [8]								
			With	Without	NH1S-2100FS- [7] [8]								
				w/Auxiliary Contact	NH1S-2111FS- [7] [8]								
				w/Alarm Contact	NH1S-2121FS- [7] [8]								
	Series Trip Current Trip	3	Tab Terminal	Without	Without				NH1S-3100- [7] [8]				
					w/Auxiliary Contact				NH1S-3111- [7] [8]				
					w/Alarm Contact				NH1S-3121- [7] [8]				
					With				Without				NH1S-3100F- [7] [8]
									w/Auxiliary Contact				NH1S-3111F- [7] [8]
									w/Alarm Contact				NH1S-3121F- [7] [8]
Screw Terminal			Without	Without	NH1S-3100S- [7] [8]								
				w/Auxiliary Contact	NH1S-3111S- [7] [8]								
				w/Alarm Contact	NH1S-3121S- [7] [8]								
			With	Without	NH1S-3100FS- [7] [8]								
				w/Auxiliary Contact	NH1S-3111FS- [7] [8]								
				w/Alarm Contact	NH1S-3121FS- [7] [8]								
Relay Trip Voltage Trip	1	Tab Terminal	Without	Without	NH1S-1500- [9]	-	-	100V AC 24V DC					
	2			Without	NH1S-2500- [9]								
	3			Without	NH1S-3500- [9]								
Dual-coil	1	Tab Terminal	Without	Without	NH1S-16- [7] [8] [9]	2 3 5 7.5 10 15	AA BA MA AD MD	100V AC 24V DC					
			With	NH1S-16F- [7] [8] [9]									
	2	Tab Terminal	Without	Without	NH1S-26- [7] [8] [9]								
			With	NH1S-26F- [7] [8] [9]									

NH1 Series Circuit Protectors

NH1Y (Rocker)

Specify a rated current, time delay curve, rated voltage, rocker indication, and rocker color in place of **7 8 9 11 12**.

Package Quantity: 1

Internal Circuit	No. of Poles	Terminal Style	Inertia Delay	Auxiliary Contact Alarm Contact	Part No.	Designation Code				
						7 Rated Current	8 Time Delay Curve	9 Rated Voltage	11 Rocker Indication	12 Rocker Color
Series Trip Current Trip	1	Tab Terminal	Without	Without	NH1Y-1100- 7 8 11 12	0.5 0.75 1 2 3 5 7.5 10 15 20 25 30	AA BA MA AD MD	-	Blank, A, C, D	Blank, R, G, W
				w/Auxiliary Contact	NH1Y-1111- 7 8 11 12					
				w/Alarm Contact	-					
		With	Without	NH1Y-1100F- 7 8 11 12						
			w/Auxiliary Contact	NH1Y-1111F- 7 8 11 12						
			w/Alarm Contact	-						
	Screw Terminal	Without	Without	NH1Y-1100S- 7 8 11 12						
			w/Auxiliary Contact	NH1Y-1111S- 7 8 11 12						
			w/Alarm Contact	-						
		With	Without	NH1Y-1100FS- 7 8 11 12						
			w/Auxiliary Contact	NH1Y-1111FS- 7 8 11 12						
			w/Alarm Contact	-						
Series Trip Current Trip	2	Tab Terminal	Without	Without	NH1Y-2100- 7 8 11 12	0.5 0.75 1 2 3 5 7.5 10 15 20 25 30	AA BA MA AD MD	-	Blank, A, C, D	Blank, R, G, W
				w/Auxiliary Contact	NH1Y-2111- 7 8 11 12					
				w/Alarm Contact	-					
		With	Without	NH1Y-2100F- 7 8 11 12						
			w/Auxiliary Contact	NH1Y-2111F- 7 8 11 12						
			w/Alarm Contact	-						
	Screw Terminal	Without	Without	NH1Y-2100S- 7 8 11 12						
			w/Auxiliary Contact	NH1Y-2111S- 7 8 11 12						
			w/Alarm Contact	-						
		With	Without	NH1Y-2100FS- 7 8 11 12						
			w/Auxiliary Contact	NH1Y-2111FS- 7 8 11 12						
			w/Alarm Contact	-						
Relay Trip Voltage Trip	1	Tab Terminal	Without	Without	NH1Y-1500- 9 11 12	-	-	100V AC 24V DC	Blank, A, C, D	Blank, R, G, W
	2			Without	NH1Y-2500- 9 11 12					
	-			-	-					

NH1 Series Circuit Protectors

NH1L (Rocker w/indicator)

Specify a rated current, time delay curve, rated voltage, indicator, rocker indicator, and rocker color in place of **7 8 9 10 11 12**. Package Quantity: 1

Internal Circuit	No. of Poles	Terminal Style	Inertia Delay	Auxiliary Contact Alarm Contact	Part No.	Designation Code					
						7 Rated Current	8 Time Delay Curve	9 Rated Voltage	10 Indicator	11 Rocker Indication	12 Rocker Color
Series Trip Current Trip	1	Tab Terminal	Without	Without	NH1L-1100- 7 8 10 11 12	0.5 0.75 1 2 3 5 7.5 10 15 20 25 30	AA BA MA AD MD	-	1: Neon 125V AC 50/60Hz 3: LED 6V AC/DC 4: LED 12V AC/DC 5: LED 24V AC/DC 7: LED 48V AC/DC	Blank, A, C, D	Blank, R, G, W
				w/Auxiliary Contact	NH1L-1111- 7 8 10 11 12						
				w/Alarm Contact	-						
		With	Without	NH1L-1100F- 7 8 10 11 12							
			w/Auxiliary Contact	NH1L-1111F- 7 8 10 11 12							
			w/Alarm Contact	-							
	Screw Terminal	Without	Without	NH1L-1100S- 7 8 10 11 12							
			w/Auxiliary Contact	NH1L-1111S- 7 8 10 11 12							
			w/Alarm Contact	-							
		With	Without	NH1L-1100FS- 7 8 10 11 12							
			w/Auxiliary Contact	NH1L-1111FS- 7 8 10 11 12							
			w/Alarm Contact	-							
Series Trip Current Trip	2	Tab Terminal	Without	Without	NH1L-2100- 7 8 10 11 12	0.5 0.75 1 2 3 5 7.5 10 15 20 25 30	AA BA MA AD MD	-	1: Neon 125V AC 50/60Hz 3: LED 6V AC/DC 4: LED 12V AC/DC 5: LED 24V AC/DC 7: LED 48V AC/DC	Blank, A, C, D	Blank, R, G, W
				w/Auxiliary Contact	NH1L-2111- 7 8 10 11 12						
				w/Alarm Contact	-						
		With	Without	NH1L-2100F- 7 8 10 11 12							
			w/Auxiliary Contact	NH1L-2111F- 7 8 10 11 12							
			w/Alarm Contact	-							
	Screw Terminal	Without	Without	NH1L-2100S- 7 8 10 11 12							
			w/Auxiliary Contact	NH1L-2111S- 7 8 10 11 12							
			w/Alarm Contact	-							
		With	Without	NH1L-2100FS- 7 8 10 11 12							
			w/Auxiliary Contact	NH1L-2111FS- 7 8 10 11 12							
			w/Alarm Contact	-							
Relay Trip Voltage Trip	1	Tab Terminal	Without	Without	NH1L-1500- 9 10 11 12	-	-	100V AC 24V DC	1: Neon 125V AC 50/60Hz 3: LED 6V AC/DC 4: LED 12V AC/DC 5: LED 24V AC/DC 7: LED 48V AC/DC	Blank, A, C, D	Blank, R, G, W
	2			Without	NH1L-2500- 9 10 11 12						
	-			-	-						

NH1 Series Circuit Protectors

NH1V (Lever)

Specify a rated current, time delay curve, and rated voltage in place of [7] [8] [9].

Package Quantity: 1

Internal Circuit	No. of Poles	Inertia Delay	Auxiliary Contact Alarm Contact	Part No.	Code for Ordering		
					[7] Rated Current	[8] Time Delay Curve	[9] Rated Voltage
Series Trip Current Trip	1	Without	Without	NH1V-1100- [7] [8]	0.5 0.75 1 2 3 5 7.5 10 15 20 25 30	AA BA MA AD MD	-
			w/Auxiliary Contact	NH1V-1111- [7] [8]			
			w/Alarm Contact	NH1V-1121- [7] [8]			
		With	Without	NH1V-1100F- [7] [8]			
			w/Auxiliary Contact	NH1V-1111F- [7] [8]			
			w/Alarm Contact	NH1V-1121F- [7] [8]			
	2	Without	Without	NH1V-2100- [7] [8]			
			w/Auxiliary Contact	NH1V-2111- [7] [8]			
			w/Alarm Contact	NH1V-2121- [7] [8]			
		With	Without	NH1V-2100F- [7] [8]			
			w/Auxiliary Contact	NH1V-2111F- [7] [8]			
			w/Alarm Contact	NH1V-2121F- [7] [8]			
	3	Without	Without	NH1V-3100- [7] [8]			
			w/Auxiliary Contact	NH1V-3111- [7] [8]			
			w/Alarm Contact	NH1V-3121- [7] [8]			
With		Without	NH1V-3100F- [7] [8]				
		w/Auxiliary Contact	NH1V-3111F- [7] [8]				
		w/Alarm Contact	NH1V-3121F- [7] [8]				
Relay Trip Voltage Trip	1	Without	Without	NH1V-1500- [9]	-	-	100V AC 24V DC
	2		Without	NH1V-2500- [9]			
	3		Without	NH1V-3500- [9]			

NH1 Series Circuit Protectors

Internal Circuits and Terminal Arrangements

Internal Circuit Model	Series Trip (Current Trip)	Series Trip (w/auxiliary contact)	Series Trip (w/alarm contact)	Relay Trip (Voltage Trip)	Dual Coil Series Trip + Relay Trip (Voltage Trip)												
NH1S																	
NH1Y			-		-												
NH1L w/indicator			-		-												
Shape (Rear View)																	
(Photo: NH1S)																	
<p>Note: The 2-pole with auxiliary or alarm contact has the contacts on the left side as viewed from the front. The 3-pole with auxiliary and alarm contacts has the contacts on the center. See the dimensional drawings for the terminal arrangement.</p> <p>• Wiring Example</p> <div style="display: flex; justify-content: space-between;"> <div style="width: 45%;"> </div> <div style="width: 45%;"> <p>• Lead Wires for Neon and LED Indicators:</p> <table border="1"> <thead> <tr> <th>Lead Wire</th> <th>Color</th> <th>Neon</th> <th>LED</th> </tr> </thead> <tbody> <tr> <td>Lead wire A</td> <td>Red</td> <td>AC</td> <td>Positive</td> </tr> <tr> <td>Lead wire B</td> <td>Black</td> <td>AC</td> <td>Negative</td> </tr> </tbody> </table> </div> </div>						Lead Wire	Color	Neon	LED	Lead wire A	Red	AC	Positive	Lead wire B	Black	AC	Negative
Lead Wire	Color	Neon	LED														
Lead wire A	Red	AC	Positive														
Lead wire B	Black	AC	Negative														

NH1V

Internal Circuit Model	Series Trip (Current Trip)	Series Trip (w/auxiliary contact)	Series Trip (w/alarm contact)	Relay Trip (Voltage Trip)
NH1V				
Shape				

Note: See the dimensional drawings for the terminal arrangement.

Overcurrent - Time Delay Characteristics (sec at 25°C) [at vertical mounting]

For	Time Delay Curve	Percent of Rated Current							
		100%	125%	150%	200%	400%	600%	800%	1000%
AC 50/60Hz	AA	No Trip	12-180	6-70	2-25	0.15-3.5	0.005-0.3	0.004-0.13	0.004-0.04
	BA	No Trip	0.7-15	0.3-4	0.1-1.3	0.02-0.25	0.006-0.13	0.003-0.07	0.003-0.04
	MA	No Trip	50-800	20-300	5.5-110	0.3-17	0.008-2.5	0.004-0.5	0.004-0.1
DC	AD	No Trip	10-180	6-75	2.6-30	0.5-7	0.015-3	0.004-0.8	0.003-0.1
	MD	No Trip	70-800	25-300	10-100	1.2-20	0.02-5	0.004-0.65	0.003-0.1

Note: Circuit protectors with inertia delay may have a slightly longer time delay at 400% or higher.

Dual Coil

For	Time Delay Curve	Percent of Rated Current							
		100%	125%	150%	200%	400%	600%	800%	1000%
AC 50/60Hz	AA	No trip	6-500	2-150	0.7-40	0.1-8	0.005-1.2	0.003-0.2	0.003-0.15
	BA	No trip	0.7-60	0.25-20	0.07-6	0.013-1.2	0.004-0.4	0.003-0.2	0.003-0.15
	MA	No trip	50-800	15-600	6-250	0.4-40	0.06-3	0.003-0.2	0.003-0.15
DC	AD	No trip	10-180	1.5-100	0.6-30	0.1-7	0.015-3	0.004-0.8	0.003-0.1
	MD	No trip	70-800	14-600	5-200	0.8-40	0.007-20	0.003-4	0.003-0.1

Note: Circuit protectors with inertia delay may have a slightly longer time delay at 400% or higher.

Time Delay Curves

Note: The dashed lines show dual coil.

For AC

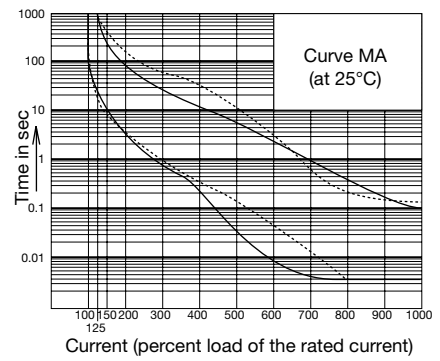
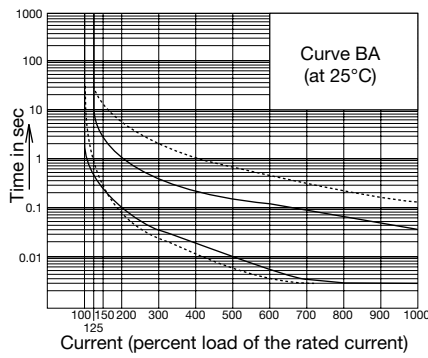
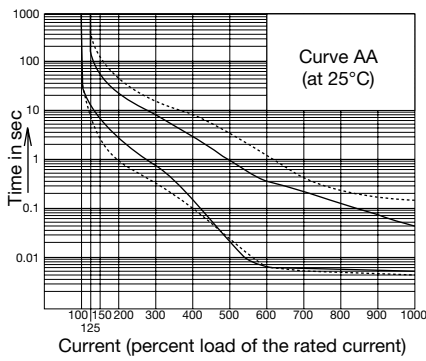

For DC

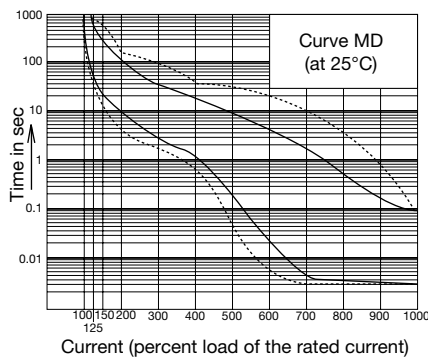
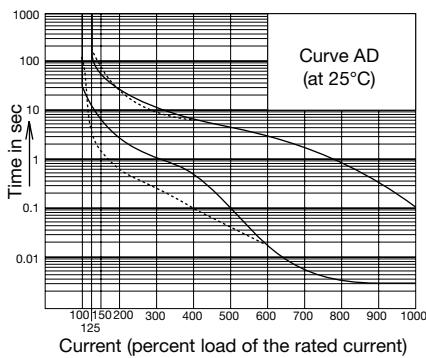

NH1 Series Circuit Protectors

Time Delay Curve and Ambient Temperature

Since NH1 series circuit protectors employ an electromagnetic tripping system, the rated current (trip current) is not affected by ambient temperatures but the time delay varies with the oil viscosity in the oil dash pot. Lower oil viscosity at higher temperatures results in shorter delay, whereas at lower temperatures the delay will be prolonged. The time delay curves on the preceding are at 25°C. With reference to these curves, time delays can be corrected.

Temperature Correction Curve

The time delay curves are at 25°C. With reference to the following figure, time delays can be corrected.

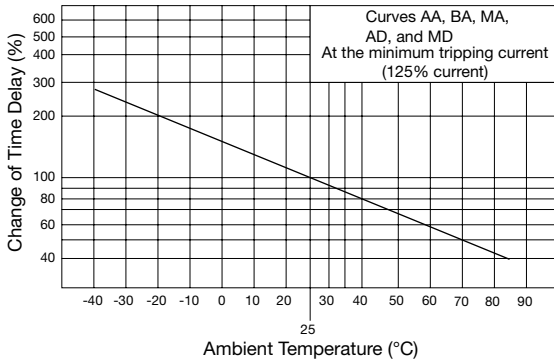

Circuit Protector with Inertia Delay

1. Circuit protectors equipped with inertia delay do not respond to high inrush currents caused by transformer or lamp loads, but perform the specified interruption on the subsequent overcurrents.
2. Inertia delay is designed not to trip on a pulse of 1500% the rated current for a duration of 10 ms.

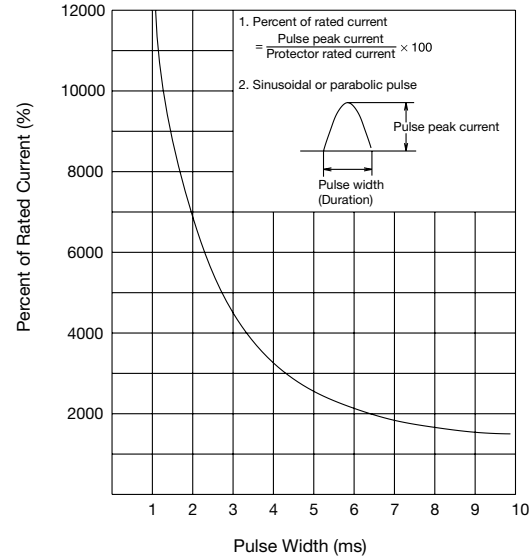

Impedance and Coil Resistance

Series Trip

[Current Trip]

Rated Current	For AC 50/60Hz Impedance (Ω)	For DC Resistance (Ω)	Rated Current	For AC 50/60Hz Impedance (Ω)	For DC Resistance (Ω)
	Curves AA, BA, and MA	Curves AD and MD		Curves AA, BA, and MA	Curves AD and MD
0.5A	3.36	3.24	7.5A	0.018	0.017
0.75A	1.49	1.45	10A	0.012	0.012
1A	0.92	0.90	15A	0.0068	0.0066
2A	0.21	0.21	20A	0.0048	0.0048
2.5A	0.13	0.13	25A	0.0043	0.0043
3A	0.092	0.09	30A	0.0041	0.0036
5A	0.036	0.036			

Note: Tolerance: ±25% (up to 5A), ±50% (7.5A or higher)

Relay Trip

[Voltage Trip]

Rated Voltage	For AC 50/60Hz Impedance (Ω)	For DC Resistance (Ω)
100V AC	1350	-
24V DC	-	248

Dual Coil

[Current Trip]

Rated Current	For AC 50/60Hz Impedance (Ω)	For DC Resistance (Ω)
	Curves AA, BA, and MA	Curves AD and MD
2A	0.308	0.307
3A	0.129	0.127
5A	0.0509	0.0518
7.5A	0.0249	0.0245
10A	0.0150	0.0150
15A	0.0084	0.0080

Note: Tolerance: ±25% (up to 5A), ±50% (7.5A or higher)

[Voltage Trip]

Rated Voltage	For AC 50/60Hz Impedance (Ω)	For DC Resistance (Ω)
100V AC	321	-
24V DC	-	15.7

Note: Tolerance: ±25%

Voltage Drop Due to Coil Resistance or Impedance

The internal resistance or impedance of a circuit protector tends to be larger for a smaller rated current. Therefore, when circuit protectors of a small rated current are used, voltage drop should be taken into consideration. Internal resistance also varies with time delay curves in spite of the same rated current, which should also be considered during installation.

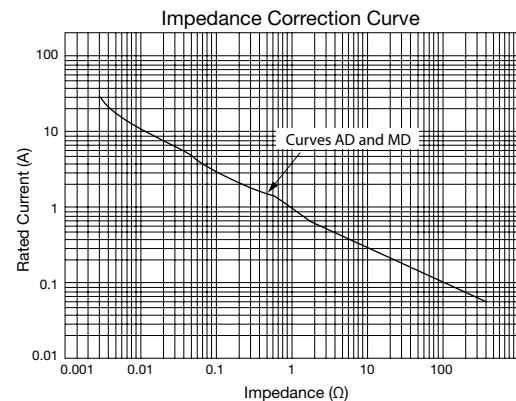
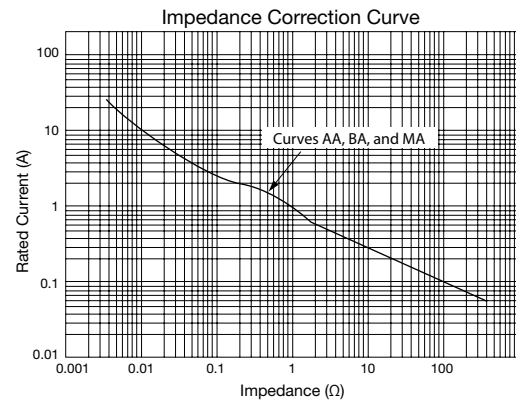

Dimensions

NH1S 1-pole

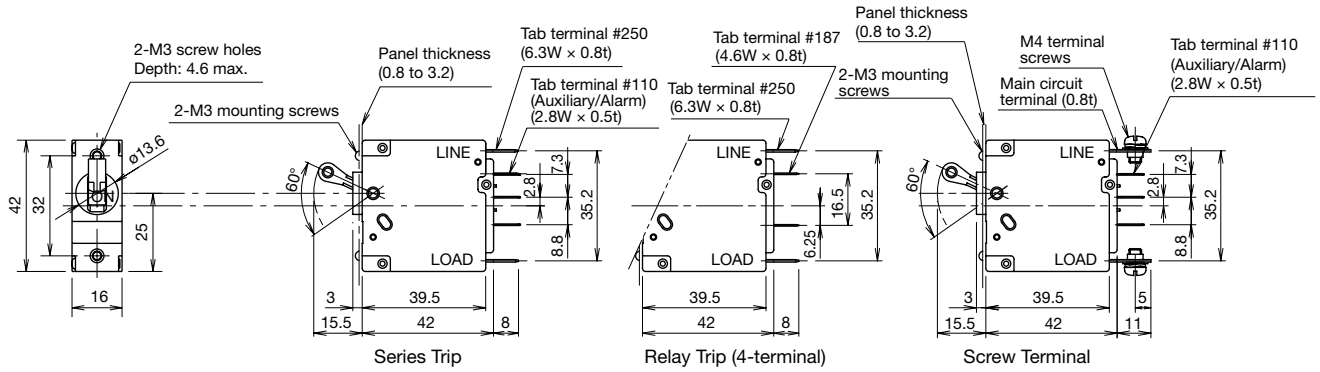

2-pole

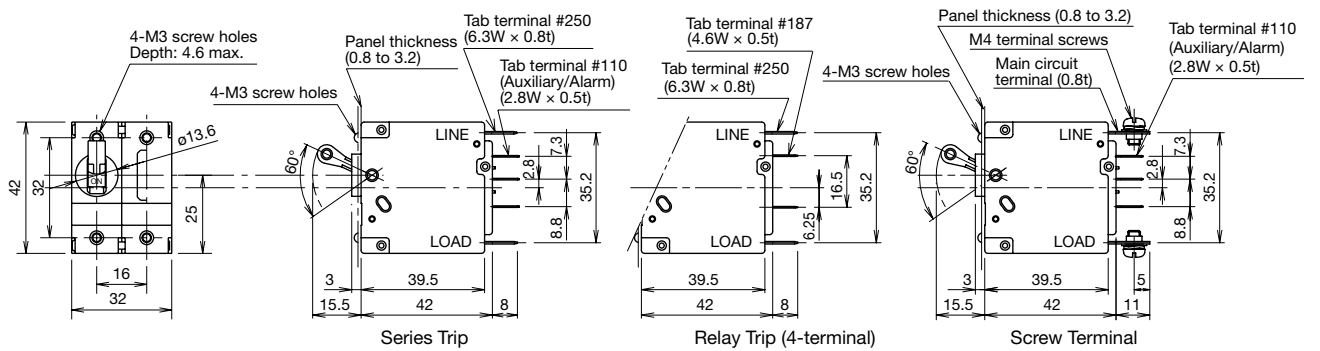

3-pole

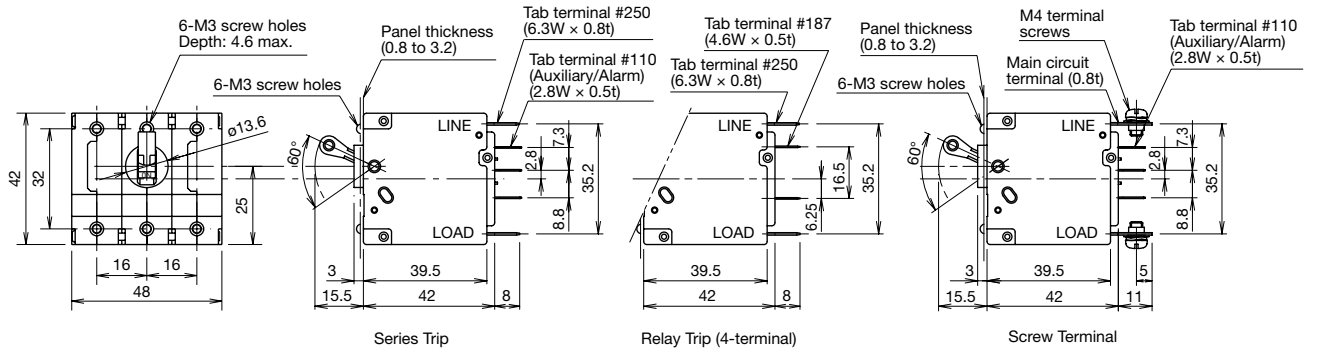

NH1Y • NH1L

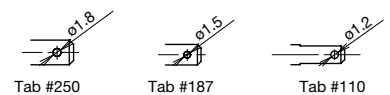
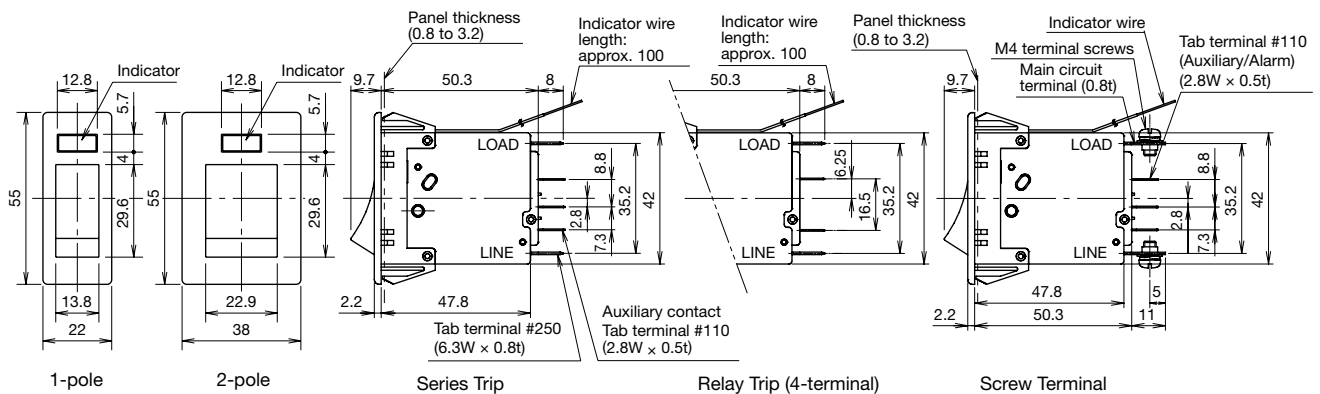

All dimensions in mm.

NH1 Series Circuit Protectors (Accessories)

Dimensions

NH1V
1-pole

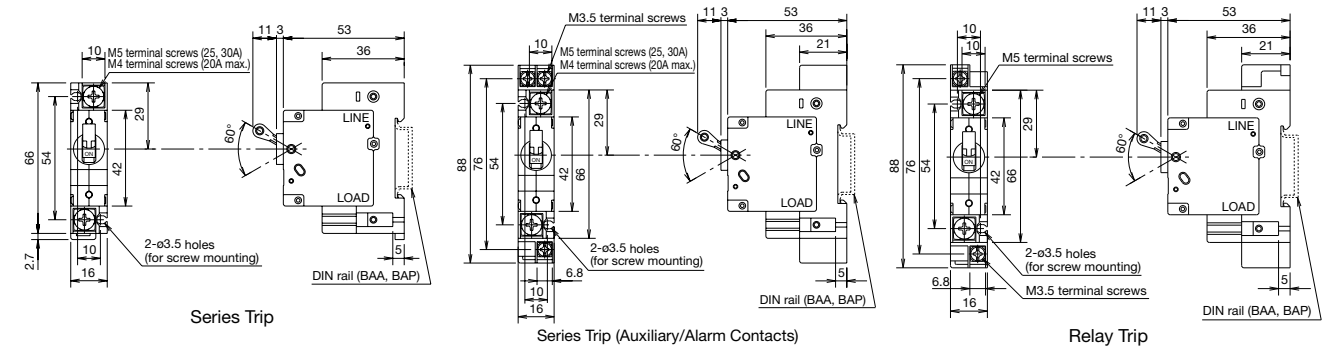

2-pole

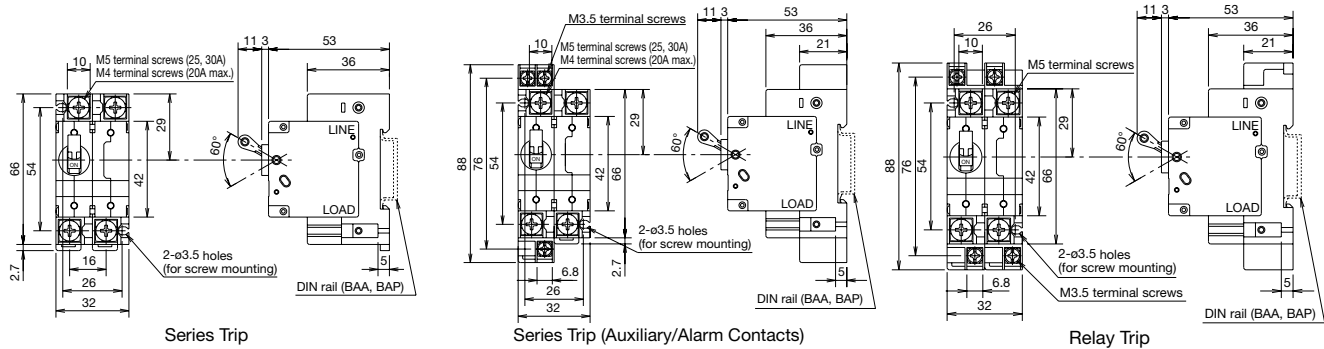

3-pole

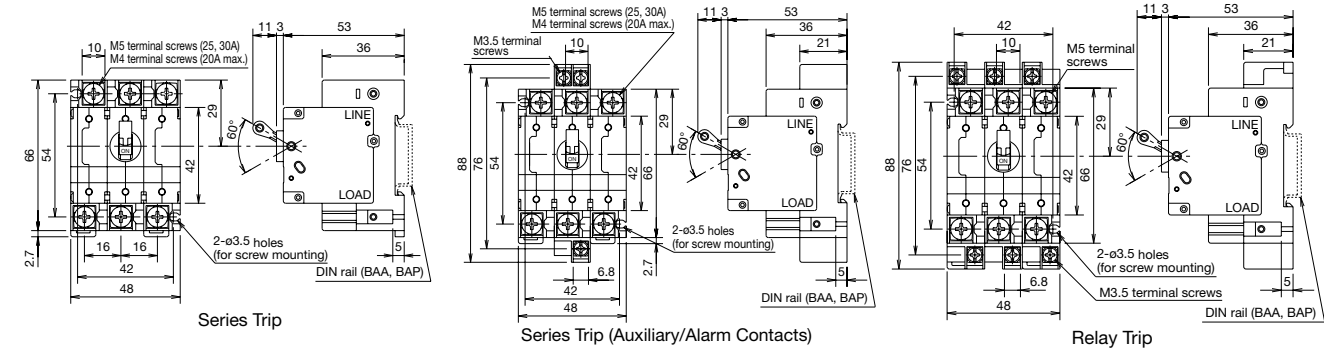

Accessories

Product / Shape	Part No.	Ordering No.	Package Quantity	Description / Dimensions
Terminal Cover (for main terminals) for NH1V  Material: Polyamide	NH9Z-A	NH9Z-APN02	2	Two pieces are required for 1 unit. 
Terminal Cover (for main/auxiliary terminals) for NH1V  Material: Polyamide	NH9Z-B	NH9Z-BPN02	2	Two pieces are required for 1 unit. 

NH1 Series Circuit Protectors Instructions

Mounting Hole Layout

NH1S

1-pole

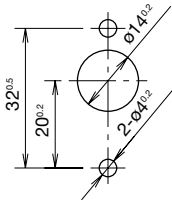

2-pole

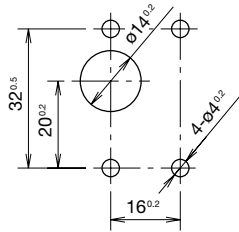

3-pole

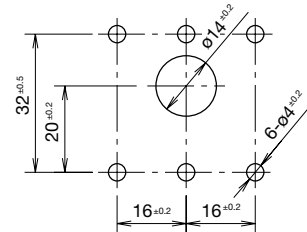

NH1Y • NH1L

1-pole

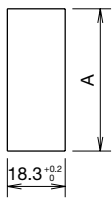

2-pole

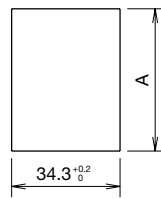

- Determine the dimension A within the panel thickness using the following formula:
 $\text{Dimension A (mm)} = 50.4 + (\text{Panel thickness} - 0.8) \times 0.87$
 Applicable panel thickness: 0.8 to 3.2 mm

Panel Mounting Screw Length

Select the screw length with reference to the following table.

Panel thickness (mm)	0.8	1.0	1.2	1.4	1.6	1.8	2.0	2.3	2.6	3.2
Without washer	5	5	5	6	6	6	6	6	7	7
With plain washer (0.5 mm thick)	5	6	6	6	6	6	7	7	7	8
With spring washer (0.7 mm thick)	6	6	6	6	6	7	7	7	7	8
With plain washer (0.5 mm thick) and spring washer (0.7 mm thick)	6	6	7	7	7	7	7	8	8	8

M3 screw mounting
 Tightening torque: 0.5 to 0.8 N·m minimum

NH1V

1-pole

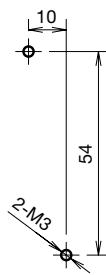

2-pole

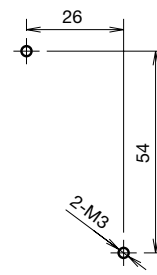

3-pole

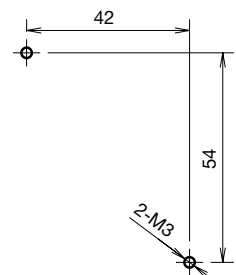

Installation Angle

Tripping method is hydraulic magnetic. Minimum operating current varies with installation angle because operating currents are influenced by the weight of movable iron core. With reference to the following figure, correct the rated current.

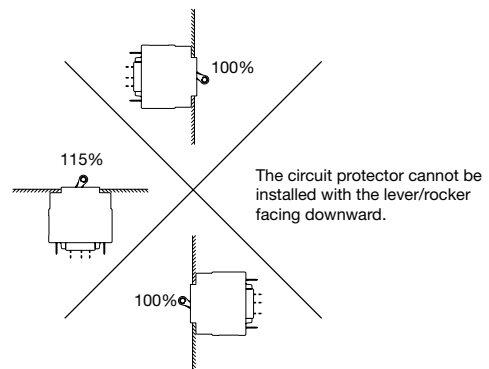

Note 1: The rated current does not change depending on the installation angle.

Note 2: The minimum operating current is calculated from the following formula:
 (Minimum operating current) = (Rated current) × 125% × (Correction factor by installation angle)

Instructions

One-pole circuit protectors cannot be combined to make 2- or 3-pole units due to their characteristics. Order multi-poles from IDEC.

Recommended Soldering Conditions

Solder the main terminal at a temperature of 390°C within 10 seconds using a 60W soldering iron.

Solder the auxiliary/alarm terminal at a temperature of 350°C within 3 seconds using a 60W soldering iron. (Sn-Ag-Cu lead-free solder is recommended.)

When soldering, do not touch the circuit protector housing, auxiliary and alarm contacts with the soldering iron, and do not bend the terminals or pull the wires.

Check your actual soldering conditions before soldering.

Main Circuit Terminal: Screw terminal

Applicable wire size	1.25 to 5.5 mm ²
Applicable crimping terminal	R1.25-4 to R5.5-4
No. of crimping terminal	1
Tightening torque	1.0 to 1.2 N·m

Thrust force (screw pressing load) in screw tightening should be 29N or less. The screw driver may slip out depending on the shape and conditions. In this case, hold the terminal with a tool and tighten the screw by applying a thrust force of about 50N without deforming the terminal.

Ordering Terms and Conditions

Thank you for using IDEC Products.

By purchasing products listed in our catalogs, datasheets, and the like (hereinafter referred to as "Catalogs") you agree to be bound by these terms and conditions. Please read and agree to the terms and conditions before placing your order.

1. Notes on contents of Catalogs

- (1) Rated values, performance values, and specification values of IDEC products listed in this Catalog are values acquired under respective conditions in independent testing, and do not guarantee values gained in combined conditions.
Also, durability varies depending on the usage environment and usage conditions.
- (2) Reference data and reference values listed in Catalogs are for reference purposes only, and do not guarantee that the product will always operate appropriately in that range.
- (3) The specifications / appearance and accessories of IDEC products listed in Catalogs are subject to change or termination of sales without notice, for improvement or other reasons.
- (4) The content of Catalogs is subject to change without notice.

2. Note on applications

- (1) If using IDEC products in combination with other products, confirm the applicable laws / regulations and standards.
Also, confirm that IDEC products are compatible with your systems, machines, devices, and the like by using under the actual conditions. IDEC shall bear no liability whatsoever regarding the compatibility with IDEC products.
- (2) The usage examples and application examples listed in Catalogs are for reference purposes only. Therefore, when introducing a product, confirm the performance and safety of the instruments, devices, and the like before use. Furthermore, regarding these examples, IDEC does not grant license to use IDEC products to you, and IDEC offers no warranties regarding the ownership of intellectual property rights or non-infringement upon the intellectual property rights of third parties.
- (3) When using IDEC products, be cautious when implementing the following.
 - i. Use of IDEC products with sufficient allowance for rating and performance
 - ii. Safety design, including redundant design and malfunction prevention design that prevents other danger and damage even in the event that an IDEC product fails
 - iii. Wiring and installation that ensures the IDEC product used in your system, machine, device, or the like can perform and function according to its specifications
- (4) Continuing to use an IDEC product even after the performance has deteriorated can result in abnormal heat, smoke, fires, and the like due to insulation deterioration or the like. Perform periodic maintenance for IDEC products and the systems, machines, devices, and the like in which they are used.
- (5) IDEC products are developed and manufactured as general-purpose products for general industrial products. They are not intended for use in the following applications, and in the event that you use an IDEC product for these applications, unless otherwise agreed upon between you and IDEC, IDEC shall provide no guarantees whatsoever regarding IDEC products.
 - i. Use in applications that require a high degree of safety, including nuclear power control equipment, transportation equipment (railroads / airplanes / ships / vehicles / vehicle instruments, etc.), equipment for use in outer space, elevating equipment, medical instruments, safety devices, or any other equipment, instruments, or the like that could endanger life or human health
 - ii. Use in applications that require a high degree of reliability, such as provision systems for gas / waterworks / electricity, etc., systems that operate continuously for 24 hours, and settlement systems
 - iii. Use in applications where the product may be handled or used deviating from the specifications or conditions / environment listed in the Catalogs, such as equipment used outdoors or applications in environments subject to chemical pollution or electromagnetic interference
If you would like to use IDEC products in the above applications, be sure to consult with an IDEC sales representative.

3. Inspections

We ask that you implement inspections for IDEC products you purchase without delay, as well as thoroughly keep in mind management/maintenance regarding handling of the product before and during the inspection.

4. Warranty

- (1) Warranty period
The warranty period for IDEC products shall be one (1) year after purchase or delivery to the specified location. However, this shall not apply in cases where there is a different specification in the Catalogs or there is another agreement in place between you and IDEC.
- (2) Warranty scope
Should a failure occur in an IDEC product during the above warranty period for reasons attributable to IDEC, then IDEC shall replace or repair that product, free of charge, at the purchase location / delivery location of the product, or an IDEC service base. However, failures caused by the following reasons shall be deemed outside the scope of this warranty.
 - i. The product was handled or used deviating from the conditions / environment listed in the Catalogs
 - ii. The failure was caused by reasons other than an IDEC product
 - iii. Modification or repair was performed by a party other than IDEC
 - iv. The failure was caused by a software program of a party other than IDEC
 - v. The product was used outside of its original purpose
 - vi. Replacement of maintenance parts, installation of accessories, or the like was not performed properly in accordance with the user's manual and Catalogs
 - vii. The failure could not have been predicted with the scientific and technical standards at the time when the product was shipped from IDEC
 - viii. The failure was due to other causes not attributable to IDEC (including cases of force majeure such as natural disasters and other disasters)Furthermore, the warranty described here refers to a warranty on the IDEC product as a unit, and damages induced by the failure of an IDEC product are excluded from this warranty.

5. Limitation of liability

The warranty listed in this Agreement is the full and complete warranty for IDEC products, and IDEC shall bear no liability whatsoever regarding special damages, indirect damages, incidental damages, or passive damages that occurred due to an IDEC product.

6. Service scope

The prices of IDEC products do not include the cost of services, such as dispatching technicians. Therefore, separate fees are required in the following cases.

- (1) Instructions for installation / adjustment and accompaniment at test operation (including creating application software and testing operation, etc.)
- (2) Maintenance inspections, adjustments, and repairs
- (3) Technical instructions and technical training
- (4) Product tests or inspections specified by you

The above content assumes transactions and usage within your region. Please consult with an IDEC sales representative regarding transactions and usage outside of your region. Also, IDEC provides no guarantees whatsoever regarding IDEC products sold outside your region.

IDEC CORPORATION

Head Office 6-64, Nishi-Miyahara-2-Chome, Yodogawa-ku, Osaka 532-0004, Japan

USA IDEC Corporation
EMEA APEM SAS

Singapore IDEC Izumi Asia Pte. Ltd.
Thailand IDEC Asia (Thailand) Co., Ltd.
India IDEC Controls India Private Ltd.

China IDEC (Shanghai) Corporation
IDEC Izumi (H.K.) Co., Ltd.
Taiwan IDEC Taiwan Corporation

Japan IDEC Corporation

 www.idec.com

Specifications and other descriptions in this brochure are subject to change without notice.

2021 IDEC Corporation, All Rights Reserved.

