

## Universal Relays

# RU Series



Full featured universal miniature relays. Designed with environment taken into consideration.



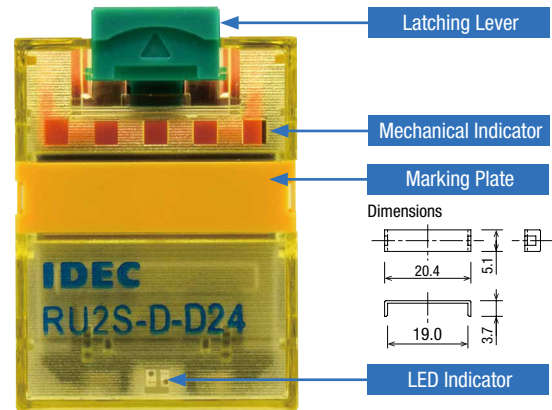
- See website for details on approvals and standards.
- Lloyd Register type approved.

## Safety

The contact position can be confirmed through the five small windows.

Using the latching lever, operation can be checked without energizing the coil. The latching lever is color coded for AC and DC coils. (AC coil: Orange DC coil: Green)

Non-polarized LED indicator available on plug-in relays.



## Reliable

No internal wires. Simple construction.

## Easy-to-Use

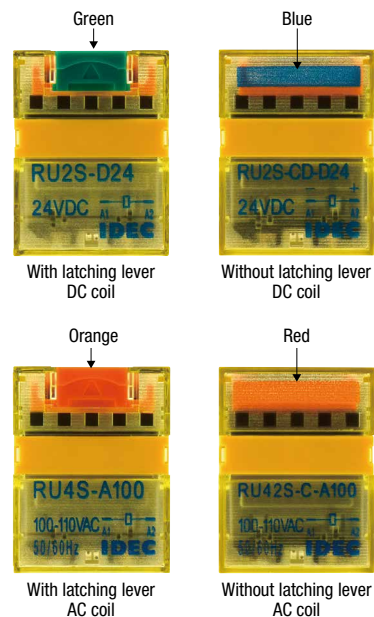
Marking plate for easy identification of relays

(Optional marking plates available in four other colors)

Applicable for small loads to maximum contact currents. (See table below)

	RU2	RU4	RU42
Max. continuous current	10A	6A	3A
Min. applicable load (Note)	24V DC 5mA	1V DC 1mA	1V DC 0.1mA

Note: Reference value.



# RU Series Universal Relays

## Single Contact

shape			 Plug-in Terminal With Latching Lever Standard (DPDT)		 PCB Terminal Without Latching Lever Standard (4PDT)	
Termination	Latching Lever	Style	Part No.		Coil Voltage Code *	
			DPDT	4PDT		
Plug-in Terminal (*1)	With Latching Lever	Standard	RU2S-*	RU4S-*	A24, A100, A110, A200, A220 D6, D12, D24, D48, D100, D110	
		With RC (AC coil only)	RU2S-R-*	RU4S-R-*	A100, A110, A200, A220	
		With diode (DC coil only)	RU2S-D-*	RU4S-D-*	D6, D12, D24, D48, D110	
		With diode (DC coil only) Reverse polarity coil	RU2S-D1-*	RU4S-D1*	D24	
	Without Latching Lever	Standard	RU2S-C-*	RU4S-C-*	A24, A100, A110, A200, A220 D6, D12, D24, D48, D100, D110	
		With RC (AC coil only)	RU2S-CR-*	RU4S-CR-*	A100, A110, A200, A220	
		With diode (DC coil only)	RU2S-CD-*	RU4S-CD-*	D6, D12, D24, D48, D110	
		With diode (DC coil only) Reverse polarity coil	RU2S-CD1-*	RU4S-CD1-*	D24	
PCB Terminal	Without Latching Lever	Simple (*2)	RU2V-NF-*	RU4V-NF-*	A24, A100, A110, A200, A220 D6, D12, D24, D48, D100, D110	

## Bifurcated Contact

shape			 Plug-in Terminal With Latching Lever Standard	
Termination	Latching Lever	Style	Part No.	Coil Voltage Code *
			4PDT	
Plug-in Terminal (*1)	With Latching Lever	Standard	RU42S-*	A24, A100, A110, A200, A220 D6, D12, D24, D48, D100, D110
		With RC (AC coil only)	RU42S-R-*	A100, A110, A200, A220
		With diode (DC coil only)	RU42S-D-*	D6, D12, D24, D48, D100, D110
		With diode (DC coil only) Reverse polarity coil	RU42S-D1-*	D24
	Without Latching Lever	Standard	RU42S-C-*	A24, A100, A110, A200, A220 D6, D12, D24, D48, D100, D110
		With RC (AC coil only)	RU42S-CR-*	A100, A110, A200, A220
		With diode (DC coil only)	RU42S-CD-*	D6, D12, D24, D48, D100, D110
		With diode (DC coil only) Reverse polarity coil	RU42S-CD1-*	D24
PCB Terminal	Without Latching Lever	Simple (*2)	RU42V-NF-*	A24, A100, A110, A200, A220 D6, D12, D24, D48, D100, D110

\*1) Plug-in terminal, except for simple types, have an LED indicator and a mechanical indicator as standard.

\*2) Simple types do not have an LED indicator, a mechanical indicator, and a latching lever.

## Accessory

Name	Part No.	Ordering No.	Color Code *	Package Quantity
Marking Plate	RU9Z-P*	RU9Z-P*PN10	A (orange), G (green), S (blue), W (white), Y (yellow)	10

Note: Specify a color code in place of the Part No. When ordering, specify the Ordering No.  
The marking plate can be removed from the relay by inserting a flat screwdriver under the marking plate.

## Part No. Development

Specify a coil voltage code in place of \* in the Part No.

Coil Voltage Code *	Coil Rating
24V AC	White
100-110V AC	Clear
110-120V AC	Blue
200-220V AC	Black
220-240V AC	Red
24V DC	Green
6V DC	Voltage marking on yellow tape
12V DC	
48V DC	
100V DC	
110V DC	

APEM

Switches & Pilot Lights

Control Boxes

Emergency Stop Switches

Enabling Switches

Safety Products

Explosion Proof

Terminal Blocks

Relays & Sockets

Circuit Protectors

Power Supplies

LED Illumination

Controllers

Operator Interfaces

Sensors

AUTO-ID

Relays

Sockets

DIN Rail Products

RJ

RU

RV8H

RL

# RU Series Universal Relays

## Coil Ratings

Rated Voltage (V)	Coil Voltage Code	Rated Current (mA) ±15% (at 20°C)		Coil Resistance (Ω) ±10% (at 20°C)	Operating Characteristics (against rated values at 20°C)			
		50 Hz	60 Hz		Maximum Continuous Applied Voltage	Minimum Pickup Voltage	Dropout Voltage	
AC (50/60 Hz)	24	A24	49.3	42.5	110%	80% maximum	30% minimum	
	100-110	A100	9.2-11.0	7.8-9.0				164
	110-120	A110	8.4-10.0	7.1-8.2				3,460
	200-220	A200	4.6-5.5	4.0-4.6				4,550
	220-240	A220	4.2-5.0	3.6-4.2				14,080
DC	6	D6	155		110%	80% maximum	10% minimum	
	12	D12	80					40
	24	D24	44.7					160
	48	D48	18					605
	100	D100	9.7					2,560
	110	D110	8.9					10,000
			12,100					

• The rated current includes the current draw by the LED indicator.

## Contact Ratings

Contact	Continuous Current	Allowable Contact Power		Voltage (V)	Rated Load			
		Resistive Load	Inductive Load		Res. Load	Ind. Load	Electrical Life (operations)	
DPDT (RU2)	10A	2500VA AC 300W DC	1250VA AC 150W DC	250 AC	10A	5A	100,000 min.	
					5A	—	500,000 min.	
					—	2.5A	300,000 min.	
				30 DC	10A	5A	100,000 min.	
					5A	—	500,000 min.	
					—	2.5A	300,000 min.	
110 DC	0.6A	0.4A	100,000 min.					
	6A	2.6A	50,000 min.					
	3A	0.8A	200,000 min.					
4PDT (RU4)	6A	1500VA AC 180W DC	600VA AC 90W DC	250 AC	6A	2.7A	50,000 min.	
					3A	1.5A	200,000 min.	
				30 DC	0.65A	0.33A	50,000 min.	
					0.33A	0.18A	200,000 min.	
				110 DC	250 AC	3A	0.8A	100,000 min.
					30 DC	3A	1.5A	100,000 min.
110 DC	0.44A	0.22A	100,000 min.					

• On 4PDT relays, the maximum allowable total current of neighboring two poles is 6A. At the rated load, make sure that the total current of neighboring two poles does not exceed 6A (3A + 3A = 6A).

## UL and c-UL Ratings

Voltage	Resistive			General Use			Horse Power Rating		
	RU2	RU4	RU42	RU2	RU4	RU42	RU2	RU4	RU42
250V AC	10A	—	—	—	6A	3A	—	1/10HP	—
30V DC	10A	6A	3A	—	—	—	—	—	—

## CSA Ratings

Voltage	Resistive								
	RU2	RU4	RU42	RU2	RU4	RU42	RU2	RU4	RU42
250V AC	10A	—	—	—	6A	3A	—	1/10HP	—
30V DC	10A	6A	3A	—	—	—	—	—	—

## TÜV Ratings

Voltage	Resistive			Inductive		
	RU2	RU4	RU42	RU2	RU4	RU42
250V AC	10A	6A	3A	5A	0.8A	0.8A
30V DC	10A	6A	3A	5A	1.5A	1.5A

## Surge Suppressor Ratings

Type	Ratings	
AC Coil	With RC	RC series circuit R: 20 kΩ, C: 0.033 μF
DC Coil	With Diode	Diode reverse voltage: 1000V Diode forward current: 1A

## Specifications

Model	RU2 (DPDT)	RU4 (4PDT)	RU42 (4PDT)
Contact Material	Silver alloy	Silver (gold clad)	Silver-nickel (gold clad)
Contact Resistance (*1)	50 mΩ maximum		
Minimum Applicable Load (*2)	24V DC, 5 mA (reference value)	1V DC, 1 mA	1V DC, 0.1 mA
Operate Time (*3)	20 ms maximum		
Release Time (*3)	20 ms maximum		
Power Consumption	AC: 1.1 to 1.4VA (50 Hz), 0.9 to 1.2VA (60 Hz) DC: 0.9 to 1.0W		
Insulation Resistance	100 MΩ minimum (500V DC megger)		
Dielectric Strength	Between contact and coil: 2500V AC, 1 minute		
	Between contacts of different poles: 2500V AC, 1 minute		
	Between contacts of the same pole: 1000V AC, 1 minute		
Operating Frequency	Electrical: 1800 operations/h maximum Mechanical: 18,000 operations/h maximum		
Vibration Resistance	Damage limits: 10 to 55 Hz, amplitude 0.5 mm Operating extremes: 10 to 55 Hz, amplitude 0.5 mm		
Shock Resistance	Damage limits: 1000 m/s <sup>2</sup> Operating extremes: 150 m/s <sup>2</sup>		
Mechanical Life	AC: 50,000,000 operations DC: 100,000,000 operations		50,000,000 operations
Electrical Life	See <b>H-019</b> and <b>H-021</b> .		
Operating Temperature (*4)	PCB terminal: -55 to +70°C (no freezing) Others: -55 to +60°C (no freezing)		
Operating Humidity	5 to 85% RH (no condensation)		
Storage Temperature	-55 to +70°C RH (no freezing)		
Storage Humidity	5 to 85% RH (no condensation)		
Weight (Approx.)	35g		

Note: Above values are initial values.

\*1) Measured using 5V DC, 1A voltage drop method

\*2) Measured at operating frequency of 120 operations/min (failure rate level P, reference value)

\*3) Measured at the rated voltage (at 20°C), excluding contact bouncing;  
Release time of AC relays with RC: 25 ms maximum  
Release time of DC relays with diode: 40 ms maximum

\*4) Measured at the rated voltage.

RU2 (DPDT Contact)

Dimensions

Plug-in Terminal



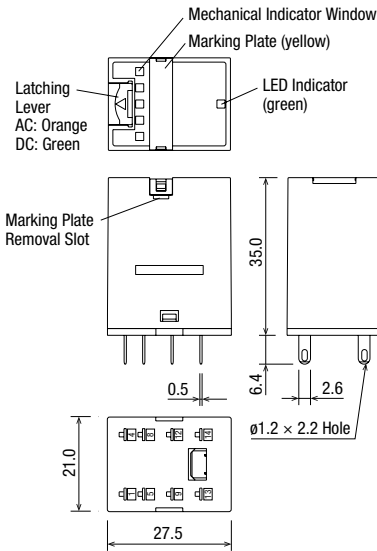
Photo: RU2S-A100

PCB Terminal

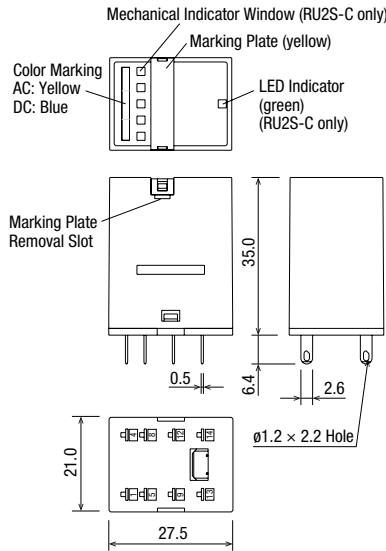


Photo: RU2V-NF-A100

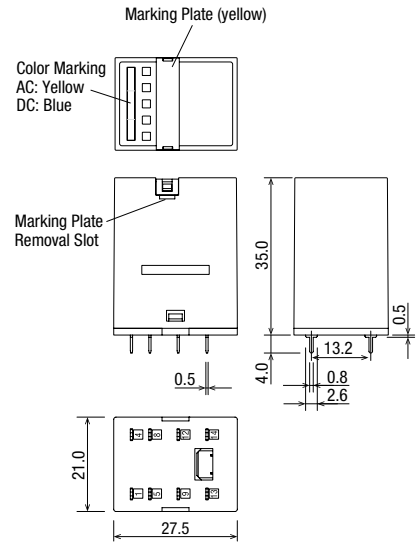
RU2S



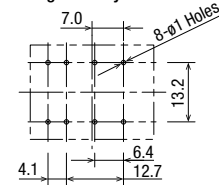
RU2S-C/RU2S-NF



RU2V



Mounting Hole Layout

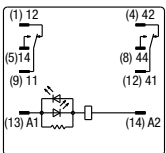


Marking plate removal slot is provided only on one side. Insert a flat screwdriver into the slot to remove the marking plate.

All dimensions in mm.

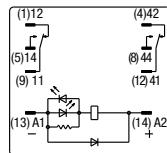
Internal Connection (Bottom View)

RU2S-\* Standard



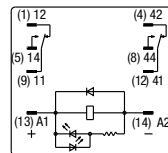
Over 24V DC

RU2S-\*D With Diode



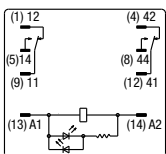
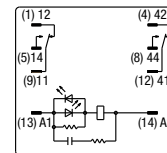
Over 24V DC

RU2S-\*D1 With Diode Reverse Polarity Coil

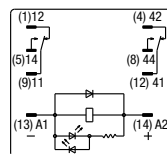


24V DC

RU2S-\*R With RC

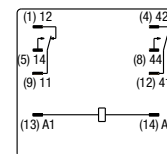


24V DC or less



24V DC or less

RU2S-NF-\*/RU2V-NF-\*



Blank or C comes in place of \* to represent types with or without a latching lever.

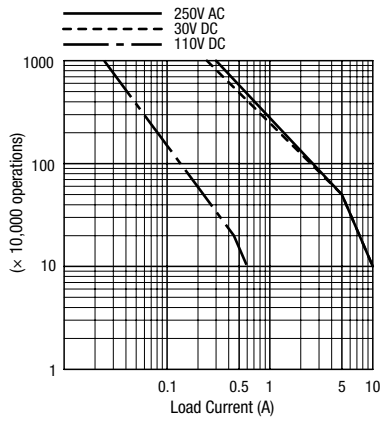
- APEM
- Switches & Pilot Lights
- Control Boxes
- Emergency Stop Switches
- Enabling Switches
- Safety Products
- Explosion Proof
- Terminal Blocks
- Relays & Sockets
- Circuit Protectors
- Power Supplies
- LED Illumination
- Controllers
- Operator Interfaces
- Sensors
- AUTO-ID

- Relays
- Sockets
- DIN Rail Products
- RJ
- RU
- RV8H
- RL

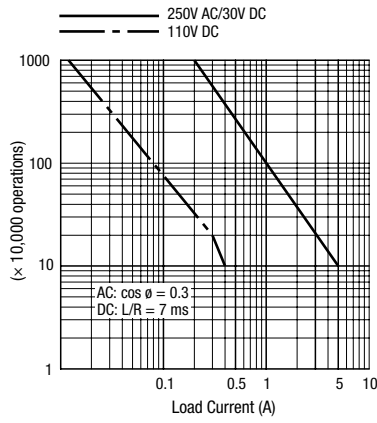
# RU Series Universal Relays

## Electrical Life Curves

RU2 (Resistive Load)

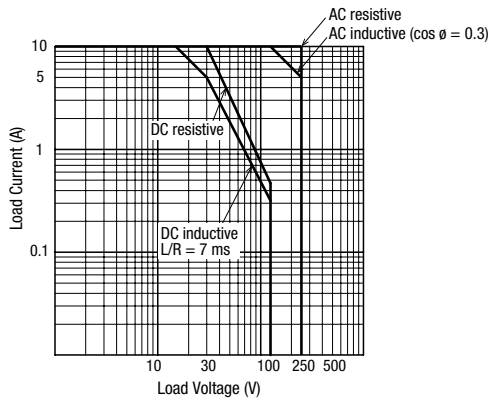


RU2 (Inductive Load)



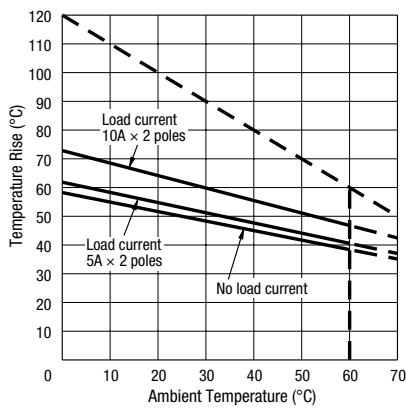
## Maximum Switching Current

RU2

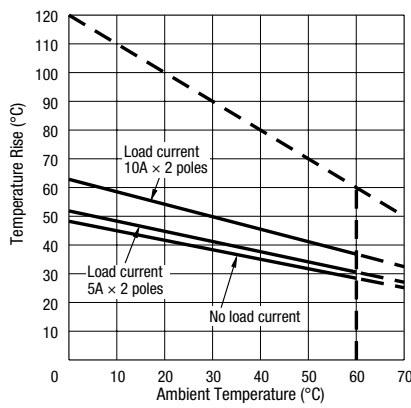


## Ambient Temperature vs. Temperature Rise Curves

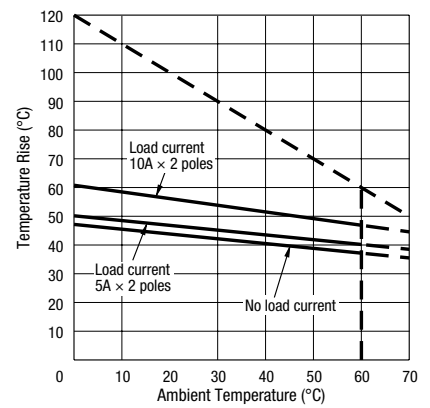
RU2 (AC Coil, 50 Hz)



RU2 (AC Coil, 60 Hz)



RU2 (DC Coil)



The above temperature rise curves show the characteristics when 100% the rated coil voltage is applied. The heat resistance of the coil is 120°C. The slant dashed line indicates the allowable temperature rise for the coil at different ambient temperatures.

- APEM
- Switches & Pilot Lights
- Control Boxes
- Emergency Stop Switches
- Enabling Switches
- Safety Products
- Explosion Proof
- Terminal Blocks
- Relays & Sockets
- Circuit Protectors
- Power Supplies
- LED Illumination
- Controllers
- Operator Interfaces
- Sensors
- AUTO-ID
- Relays
- Sockets
- DIN Rail Products

RU4 (4PDT Contact)

Dimensions

Plug-in Terminal



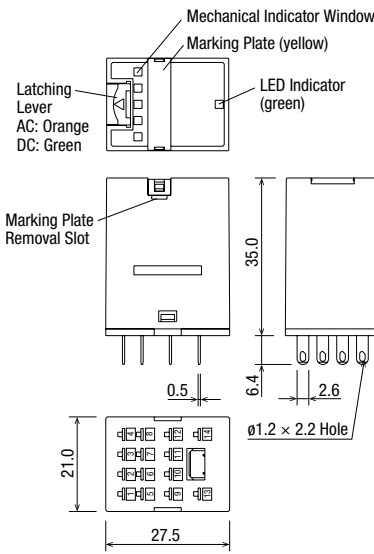
Photo: RU42S-A100

PCB Terminal

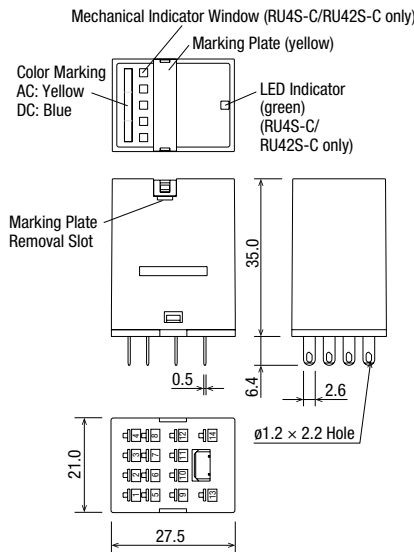


Photo: RU4V-NF-D24

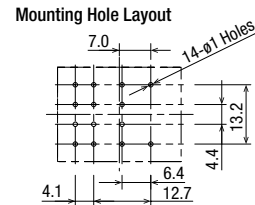
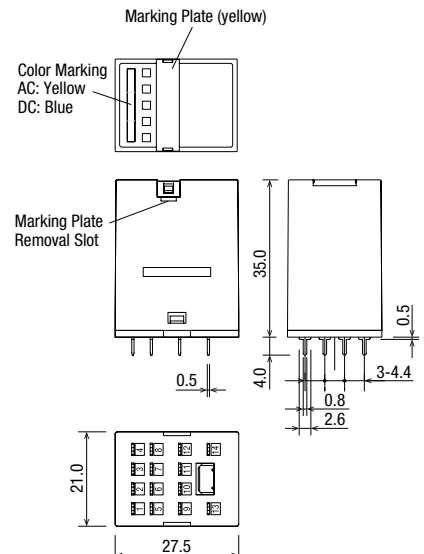
RU4S/RU42S



RU4S-C/RU4S-NF  
RU42S-C/RU42S-NF



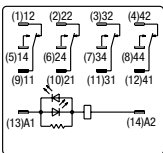
RU4V/RU42V



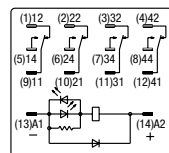
Marking plate removal slot is provided only on one side. Insert a flat screwdriver into the slot to remove the marking plate.

Internal Connection (Bottom View)

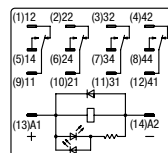
RU4S-\*/RU42S-\*  
Standard



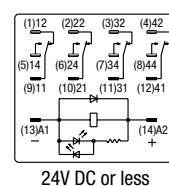
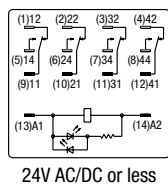
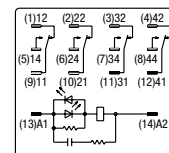
RU4S-\*D/RU42S-\*D  
With Diode



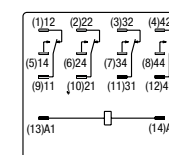
RU4S-\*D1/RU42S-\*D1  
With Diode Reverse Polarity Coil



RU4S-\*R/RU42S-\*R  
With RC



RU4S-NF-\*/RU4V-NF-\*  
RU42S-NF-\*/RU42V-NF-\*



Blank or C comes in place of \* to represent types with or without a latching lever.

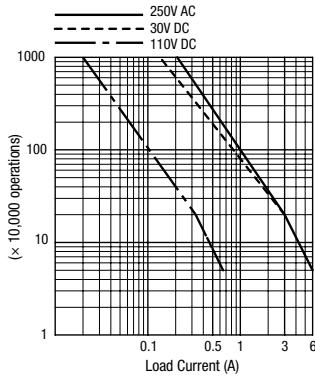
- APEM
- Switches & Pilot Lights
- Control Boxes
- Emergency Stop Switches
- Enabling Switches
- Safety Products
- Explosion Proof
- Terminal Blocks
- Relays & Sockets
- Circuit Protectors
- Power Supplies
- LED Illumination
- Controllers
- Operator Interfaces
- Sensors
- AUTO-ID
- Relays
- Sockets
- DIN Rail Products
- RJ
- RU
- RV8H
- RL



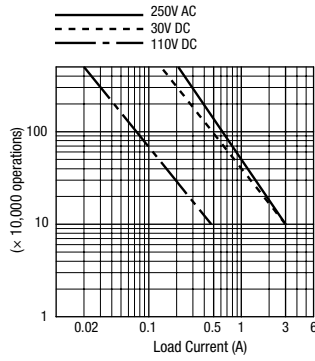
# RU Series Universal Relays

## Electrical Life Curves

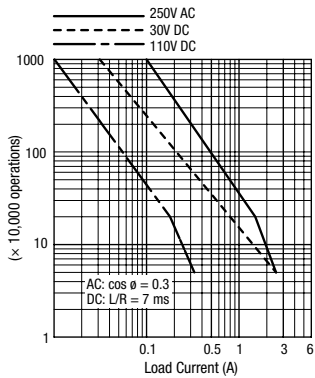
**RU4 (Resistive Load)**



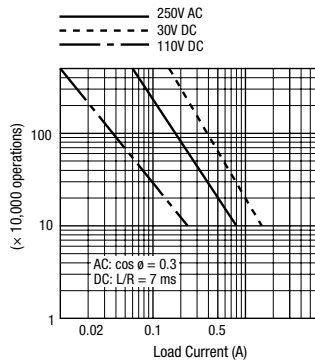
**RU42 (Resistive Load)**



**RU4 (Inductive Load)**

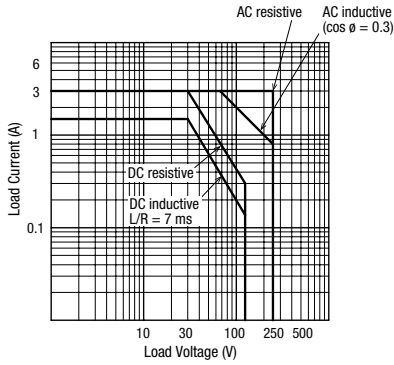


**RU42 (Inductive Load)**

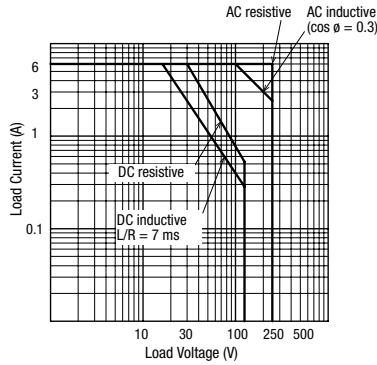


## Maximum Switching Current

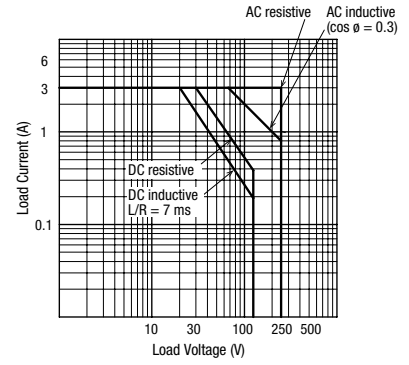
**RU4 (Rated Load)**



**RU4 (Maximum Load)**

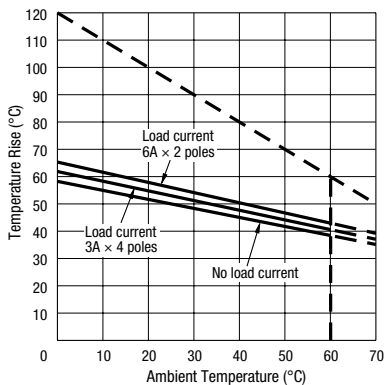


**RU42**

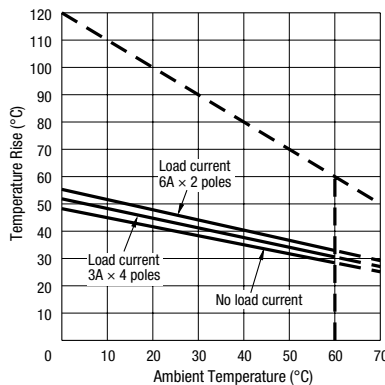


## Ambient Temperature vs. Temperature Rise Curves

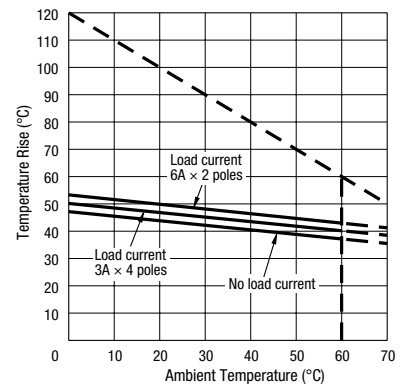
**RU4/RU42 (AC Coil, 50 Hz)**



**RU4/RU42 (AC Coil, 60 Hz)**






































**RU4/RU42 (DC Coil)**



The above temperature rise curves show the characteristics when 100% the rated coil voltage is applied. Load current 6A x 2 poles is for the RU4 only.

The heat resistance of the coil is 120°C. The slant dashed line indicates the allowable temperature rise for the coil at different ambient temperatures.

Applicable Socket

Relay	Wiring Style	Shape	Part No.	Rated Current	Style	Applicable Spring		
						Hold-down Spring	Wire Spring	
RU2	Front Wiring Socket		SM2S-05B	7A	Standard 	SFA-202 SFA-101	—	
			SM2S-05C (*1)	7A (UL: 10A)	Finger-safe 			
			SN2S-05D	10A	Standard 	SFA-503		
			SM2S-05DF (*1)	10A	Finger-safe 			
			SU2S-11L	10A 8A (collective mounting) (*3)	Spring clamp (*2) 	SFA-202 SFA-101		—
			SU2S-21L	12A	Push-in (*5) 	—		
	Rear Wiring Socket		SM2S-51	10A	Solder 	SFA-301 SFA-302	SY4S-51F1	
			SM2S-61	10A	PC board 			
			SM2S-62	10A	PC board 	SFA-504		SY4S-51F1
RU4 RU42	Front Wiring Socket		SY4S-05B	7A	Standard 	SFA-202 SFA-101	—	
			SY4S-05C (*1)	7A	Finger-safe 			
			SN4S-05D	6A	Standard 	SFA-502		
			SY4S-05DF (*1)	6A	Finger-safe 	SFA-502		
			SU4S-11L	6A (4-pole) 10A (2-pole) 8A (2-pole, collective mounting) (*3)	Spring clamp (*2) 	SFA-202 SFA-101		—
			SU4S-21L	8A	Push-in (*5) 	—		
	Rear Wiring Socket		SY4S-51	7A	Solder 	SFA-301 SFA-302	SY4S-51F1	
			SY4S-61	7A	PC board 			
			SY4S-62	7A	PC board 	SFA-504		SY4S-51F1

\*1) Finger-safe cannot be used with ring terminal.

\*2) SU2S-11L and SU4S-11L are spring-clamp socket which does not require tightening screws. Stranded wire, solid wire, and ferrule can be attached using a screwdriver.

\*3) When using SU2S-11L and SU4S-11L at rated current 8A and above, maintain at least 10mm distance from the adjacent SU socket.

\*4) Front wiring socket can be mounted directly on DIN rail and mounting panel (some sockets need spacers for the ends).

\*5) SU2S-21L and SU4S-21L are Push-in socket which does not require tightening screws. Stranded wire, solid wire, and ferrule can be attached using a screwdriver.

- APEM
- Switches & Pilot Lights
- Control Boxes
- Emergency Stop Switches
- Enabling Switches
- Safety Products
- Explosion Proof
- Terminal Blocks
- Relays & Sockets
- Circuit Protectors
- Power Supplies
- LED Illumination
- Controllers
- Operator Interfaces
- Sensors
- AUTO-ID

Relays

- Sockets
- DIN Rail Products

RJ

RU

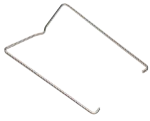







RV8H

RL



## RU Series Universal Relays

### Hold-down Springs

Style	Shape	Material	Part No.	Ordering No.	Package Quantity
Wire Spring		Stainless Steel	SY4S-51F1	SY4S-51F1PN10	10
Leaf Spring			SFA-101	SFA-101PN20	10 pairs
			SFA-202	SFA-202PN20	
			SFA-301	SFA-301PN20	
			SFA-302	SFA-302PN20	
			SFA-502	SFA-502PN20	
			SFA-503	SFA-503PN20	
			SFA-504	SFA-504PN10	

- A relay needs a pair of leaf springs, except for SFA-504 (one spring per relay).
- When the wire spring SY4S-51F1 or leaf spring SFA-504 is used on a relay with latching lever, lever cannot be opened or closed.
- Leaf springs (except for the leaf spring SFA-504) cannot be removed after being installed on a socket.







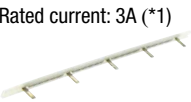
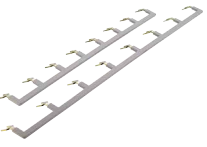
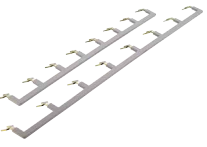
RJ

RU

RV8H

RL

Accessories for Sockets

Name	Shape	Specifications	Part No.	Ordering No.	Package Quantity	Remarks
DIN Rail		Aluminum Weight: Approx. 200g	BAA1000	BAA1000PN10	10	Length: 1m Width: 35 mm
End Clip		Zinc-plated steel Weight: Approx. 15g	BNL5	BNL5PN10	10	Used on a DIN rail to fasten relay sockets
			BNL6	BNL6PN10	10	
DIN Rail Spacer		Plastic (black)	SA-406B	SA-406B	1	Thickness: 5 mm Used for adjusting spacing between sockets mounted on a DIN rail
End Spacer		Plastic (black)	SA-203B	SA-203B	1	Used for mounting DIN rail mount sockets directly on a panel surface
			SA-204B	SA-204B	1	
Jumper		Rated current: 3A (*1) Brass jumper with ABS sheath Rated current: 3A Weight: Approx. 3g	SU9Z-J5	SU9Z-J5PN10	10	Used for interconnecting relay coil terminals on a maximum of five SU sockets; can be cut to required lengths
Jumper (for 2-pole socket)		Rated current: 10A (*1) Brass (Nickel-plated) with polyprene sheath	SM9Z-JF2	SM9Z-JF2PN10	10	Used for interconnecting relay coil terminals on SM2S-05DF sockets; can be cut to required length. No. of sockets: SM9Z-JF2: 2 SM9Z-JF5: 5 SM9Z-JF8: 8
			SM9Z-JF5	SM9Z-JF5PN10		
			SM9Z-JF8	SM9Z-JF8PN10		
Jumper (for 4-pole socket)		Rated current: 10A (*1) Brass (Nickel-plated) with polyprene sheath	SY9Z-JF2	SY9Z-JF2PN10	10	Used for interconnecting relay coil terminals on SY4S-05DF sockets; can be cut to required length SY9Z-JF2: 2 SY9Z-JF5: 5 SY9Z-JF8: 8
			SY9Z-JF5	SY9Z-JF5PN10		
			SY9Z-JF8	SY9Z-JF8PN10		

\*1) Ensure that the total current to the jumper does not exceed the rated current.

- APEM
- Switches & Pilot Lights
- Control Boxes
- Emergency Stop Switches
- Enabling Switches
- Safety Products
- Explosion Proof
- Terminal Blocks
- Relays & Sockets
- Circuit Protectors
- Power Supplies
- LED Illumination
- Controllers
- Operator Interfaces
- Sensors
- AUTO-ID
- Relays
- Sockets
- DIN Rail Products
- RJ
- RU
- RV8H
- RL

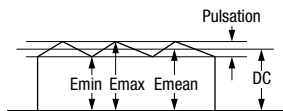
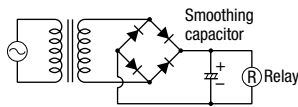
## Safety Precautions

- Turn off the power to the relay before starting installation, removal, wiring, maintenance, and inspection of the relays. Failure to turn power off may cause electrical shock or fire hazard.
- Observe specifications and rated values, otherwise electrical shock or fire hazard may be caused.
- Use wires of the proper size to meet the voltage and current requirements. Tighten the terminal screws on the relay socket to the proper tightening torque.
- Before operating the latching lever, turn off the power to the RU relay. After checking the circuit, return the latching lever to the original position.
- Do not use the latching lever as a switch.
- The durability of the latching lever is a minimum of 100 operations.
- When using DC loads on 4PDT relays, apply a positive voltage to terminals of neighboring poles and a negative voltage to the other terminals of neighboring poles to prevent the possibility of short circuits.
- DC relays with a diode have a polarity in the coil terminals.
- The surge absorbing element on AC relays with RC or DC relays. with diode is provided to absorb the counter electromotive force generated by the coil. When the relay is subject to an excessive external surge voltage, the surge absorbing element may be damaged. Add another surge absorbing provision to the relay to prevent damage.

## Instructions

### Driving Circuit for Relays

1. To make sure of correct relay operation, apply rated voltage to the relay coil.
2. Input voltage for the DC coil:  
A complete DC voltage is best for the coil power to make sure of stable relay operation. When using a power supply containing a ripple voltage, suppress the ripple factor within 5%. When power is supplied through a rectification circuit, the relay operating characteristics, such as pickup voltage and dropout voltage, depend on the ripple factor. Connect a smoothing capacitor for better operating characteristics as shown below.



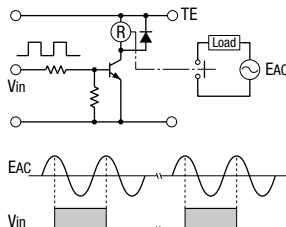
$$\text{Ripple factor (\%)} = \frac{E_{\max} - E_{\min}}{E_{\text{mean}}} \times 100\%$$

$E_{\max}$  = Maximum of pulsating current

$E_{\min}$  = Minimum of pulsating current

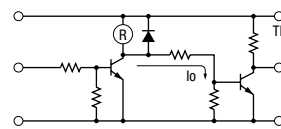
$E_{\text{mean}}$  = DC mean value

3. Operating the relay in synchronism with AC load:  
If the relay operates in synchronism with the AC power voltage of the load, the relay life may be reduced. If this is the case, select a relay in consideration of the required reliability for the load. Or, make the relay turn on and off irrespective of the AC power phase or near the point where the AC phase crosses zero voltage.

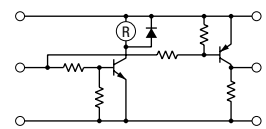


4. Leakage current while relay is off:  
When driving an element at the same time as the relay operation, a special consideration is needed for the circuit design. As shown in the incorrect circuit below, Leakage current ( $I_o$ ) flows through the relay coil while the relay is off. Leakage current causes the coil release failure or adversely affects the vibration resistance and shock resistance. Design a circuit as shown in the correct example.

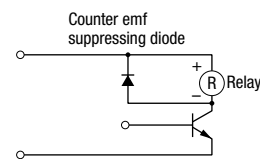
Incorrect



Correct



5. Surge suppression for transistor driving circuits:  
When the relay coil is turned off, a high-voltage pulse is generated, causing the transistor to deteriorate and sometimes to break. Be sure to connect a diode to suppress the counter electromotive force. Then, the coil release time becomes slightly longer. To shorten the coil release time, connect a Zener diode between the collector and emitter of the transistor. Select a Zener diode with a Zener voltage slightly higher than the power voltage.



APEM
Switches & Pilot Lights
Control Boxes
Emergency Stop Switches
Enabling Switches
Safety Products
Explosion Proof
Terminal Blocks
Relays & Sockets
Circuit Protectors
Power Supplies
LED Illumination
Controllers
Operator Interfaces
Sensors
AUTO-ID

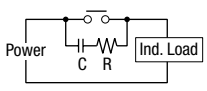
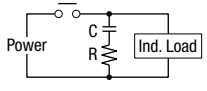
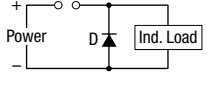
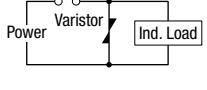
Relays
Sockets
DIN Rail Products

RJ
RU
RV8H
RL

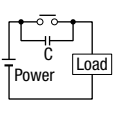
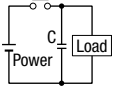
## Instructions

### Protection for Relay Contacts

- The contact ratings show maximum values. Make sure that these values are not exceeded. When an inrush current flows through the load, the contact may become welded. If this is the case, connect a contact protection circuit, such as a current limiting resistor.
- Contact protection circuit:  
When switching an inductive load, arcing causes carbides to form on the contacts, resulting in an increased contact resistance. In consideration of contact reliability, contact life, and noise suppression, use of a surge absorbing circuit is recommended. Note that the release time of the load becomes slightly longer. Check the operation using the actual load. Incorrect use of a contact protection circuit will adversely affect switching characteristics. Four typical examples of contact protection circuits are shown in the following table:

RC		This protection circuit can be used when the load impedance is smaller than the RC impedance in an AC load power circuit. R: Resistor of approximately the same resistance value as the load C: 0.1 to 1 μF
		This protection circuit can be used for both AC and DC load power circuits. R: Resistor of approximately the same resistance value as the load C: 0.1 to 1 μF
Diode		This protection circuit can be used for DC load power circuits. Use a diode with the following ratings. Reverse withstand voltage: Power voltage of the load circuit × 10 Forward current: More than the load current
Varistor		This protection circuit can be used for both AC and DC load power circuits. For a best result, when using on a power voltage of 24 to 48V AC/DC, connect a varistor across the load. When using on a power voltage of 100 to 240V AC/DC, connect a varistor across the contacts.

- Do not use a contact protection circuit as shown below:

	This protection circuit is very effective in arc suppression when opening the contacts. But, the capacitor is charged while the contacts are opened. When the contacts are closed, the capacitor is discharged through the contacts, increasing the possibility of contact welding.
	This protection circuit is very effective in arc suppression when opening the contacts. But, when the contacts are closed, a current flows to charge the capacitor, causing contact welding.

Generally, switching a DC inductive load is more difficult than switching a DC resistive load. Using an appropriate arc suppressor, however, will improve the switching characteristics of a DC inductive load.

### Other Precautions

- General notice:  
To maintain the initial characteristics, do not drop the relay or shock the relay.  
The relay cover cannot be removed from the base during normal operation. To maintain the initial characteristics, do not remove the relay cover.  
Use the relay in environments free from condensation of dust, sulfur dioxide (SO<sub>2</sub>), and hydrogen sulfide (H<sub>2</sub>S).  
Make sure that the coil voltage does not exceed the applicable coil voltage range.
- Connecting outputs to electronic circuits:  
When the output is connected to a load which responds very quickly, such as an electronic circuit, contact bouncing causes incorrect operation of the load. Take the following measures into consideration.  
Connect an integral circuit.  
Suppress the pulse voltage due to bouncing within the noise margin of the load.
- UL- and CSA-approved ratings may differ from product rated values determined by IDEC.
- Do not use relays in the vicinity of strong magnetic field as this may affect relay operation.  
DC diode type has polarity.  
The surge absorbing element on AC relays with RC or DC relays with diode is provided to absorb the counter electromotive force generated by the coil. When the relay is subject to an excessive external surge voltage, the surge absorbing element may be damaged. Add another surge absorbing provision to the relay to prevent damage.

# Ordering Terms and Conditions

Thank you for using IDEC Products.

By purchasing products listed in our catalogs, datasheets, and the like (hereinafter referred to as "Catalogs") you agree to be bound by these terms and conditions. Please read and agree to the terms and conditions before placing your order.

## 1. Notes on contents of Catalogs

- (1) Rated values, performance values, and specification values of IDEC products listed in this Catalog are values acquired under respective conditions in independent testing, and do not guarantee values gained in combined conditions.  
Also, durability varies depending on the usage environment and usage conditions.
- (2) Reference data and reference values listed in Catalogs are for reference purposes only, and do not guarantee that the product will always operate appropriately in that range.
- (3) The specifications / appearance and accessories of IDEC products listed in Catalogs are subject to change or termination of sales without notice, for improvement or other reasons.
- (4) The content of Catalogs is subject to change without notice.

## 2. Note on applications

- (1) If using IDEC products in combination with other products, confirm the applicable laws / regulations and standards.  
Also, confirm that IDEC products are compatible with your systems, machines, devices, and the like by using under the actual conditions. IDEC shall bear no liability whatsoever regarding the compatibility with IDEC products.
- (2) The usage examples and application examples listed in Catalogs are for reference purposes only. Therefore, when introducing a product, confirm the performance and safety of the instruments, devices, and the like before use. Furthermore, regarding these examples, IDEC does not grant license to use IDEC products to you, and IDEC offers no warranties regarding the ownership of intellectual property rights or non-infringement upon the intellectual property rights of third parties.
- (3) When using IDEC products, be cautious when implementing the following.
  - i. Use of IDEC products with sufficient allowance for rating and performance
  - ii. Safety design, including redundant design and malfunction prevention design that prevents other danger and damage even in the event that an IDEC product fails
  - iii. Wiring and installation that ensures the IDEC product used in your system, machine, device, or the like can perform and function according to its specifications
- (4) Continuing to use an IDEC product even after the performance has deteriorated can result in abnormal heat, smoke, fires, and the like due to insulation deterioration or the like. Perform periodic maintenance for IDEC products and the systems, machines, devices, and the like in which they are used.
- (5) IDEC products are developed and manufactured as general-purpose products for general industrial products. They are not intended for use in the following applications, and in the event that you use an IDEC product for these applications, unless otherwise agreed upon between you and IDEC, IDEC shall provide no guarantees whatsoever regarding IDEC products.
  - i. Use in applications that require a high degree of safety, including nuclear power control equipment, transportation equipment (railroads / airplanes / ships / vehicles / vehicle instruments, etc.), equipment for use in outer space, elevating equipment, medical instruments, safety devices, or any other equipment, instruments, or the like that could endanger life or human health
  - ii. Use in applications that require a high degree of reliability, such as provision systems for gas / waterworks / electricity, etc., systems that operate continuously for 24 hours, and settlement systems
  - iii. Use in applications where the product may be handled or used deviating from the specifications or conditions / environment listed in the Catalogs, such as equipment used outdoors or applications in environments subject to chemical pollution or electromagnetic interference  
If you would like to use IDEC products in the above applications, be sure to consult with an IDEC sales representative.

## 3. Inspections

We ask that you implement inspections for IDEC products you purchase without delay, as well as thoroughly keep in mind management/maintenance regarding handling of the product before and during the inspection.

## 4. Warranty

- (1) Warranty period  
The warranty period for IDEC products shall be one (1) year after purchase or delivery to the specified location. However, this shall not apply in cases where there is a different specification in the Catalogs or there is another agreement in place between you and IDEC.
- (2) Warranty scope  
Should a failure occur in an IDEC product during the above warranty period for reasons attributable to IDEC, then IDEC shall replace or repair that product, free of charge, at the purchase location / delivery location of the product, or an IDEC service base. However, failures caused by the following reasons shall be deemed outside the scope of this warranty.
  - i. The product was handled or used deviating from the conditions / environment listed in the Catalogs
  - ii. The failure was caused by reasons other than an IDEC product
  - iii. Modification or repair was performed by a party other than IDEC
  - iv. The failure was caused by a software program of a party other than IDEC
  - v. The product was used outside of its original purpose
  - vi. Replacement of maintenance parts, installation of accessories, or the like was not performed properly in accordance with the user's manual and Catalogs
  - vii. The failure could not have been predicted with the scientific and technical standards at the time when the product was shipped from IDEC
  - viii. The failure was due to other causes not attributable to IDEC (including cases of force majeure such as natural disasters and other disasters)Furthermore, the warranty described here refers to a warranty on the IDEC product as a unit, and damages induced by the failure of an IDEC product are excluded from this warranty.

## 5. Limitation of liability

The warranty listed in this Agreement is the full and complete warranty for IDEC products, and IDEC shall bear no liability whatsoever regarding special damages, indirect damages, incidental damages, or passive damages that occurred due to an IDEC product.

## 6. Service scope

The prices of IDEC products do not include the cost of services, such as dispatching technicians. Therefore, separate fees are required in the following cases.

- (1) Instructions for installation / adjustment and accompaniment at test operation (including creating application software and testing operation, etc.)
- (2) Maintenance inspections, adjustments, and repairs
- (3) Technical instructions and technical training
- (4) Product tests or inspections specified by you

The above content assumes transactions and usage within your region. Please consult with an IDEC sales representative regarding transactions and usage outside of your region. Also, IDEC provides no guarantees whatsoever regarding IDEC products sold outside your region.

# IDEC CORPORATION

**Head Office** 6-64, Nishi-Miyahara-2-Chome, Yodogawa-ku, Osaka 532-0004, Japan

**USA** IDEC Corporation  
**EMEA** APEM SAS

**Singapore** IDEC Izumi Asia Pte. Ltd.  
**Thailand** IDEC Asia (Thailand) Co., Ltd.  
**India** IDEC Controls India Private Ltd.

**China** IDEC (Shanghai) Corporation  
IDEC Izumi (H.K.) Co., Ltd.  
**Taiwan** IDEC Taiwan Corporation

 [www.idec.com](http://www.idec.com)

**Japan** IDEC Corporation

Specifications and other descriptions in this brochure are subject to change without notice.

2023 IDEC Corporation, All Rights Reserved.

